

# INSTRUMENT CATALOGUE



## **CANWELL MEDICAL CO., LTD**

Add: No.466 South Xianhua Street, Jinhua, Zhejiang, 321016, PR. of China

Tel: +86-579-8911-9170

Fax: +86-579-8391-3800

E-Mail: [export@canwell.com.cn](mailto:export@canwell.com.cn)

Web: <http://www.canwell.com.cn>

[www.canwell.com.cn](http://www.canwell.com.cn)

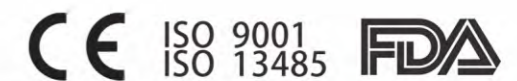

## Clavicle

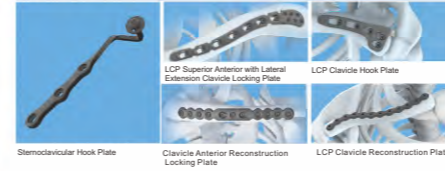

## Humerus



## Radius and Ulna



## Femur



## Tibia and Fibula

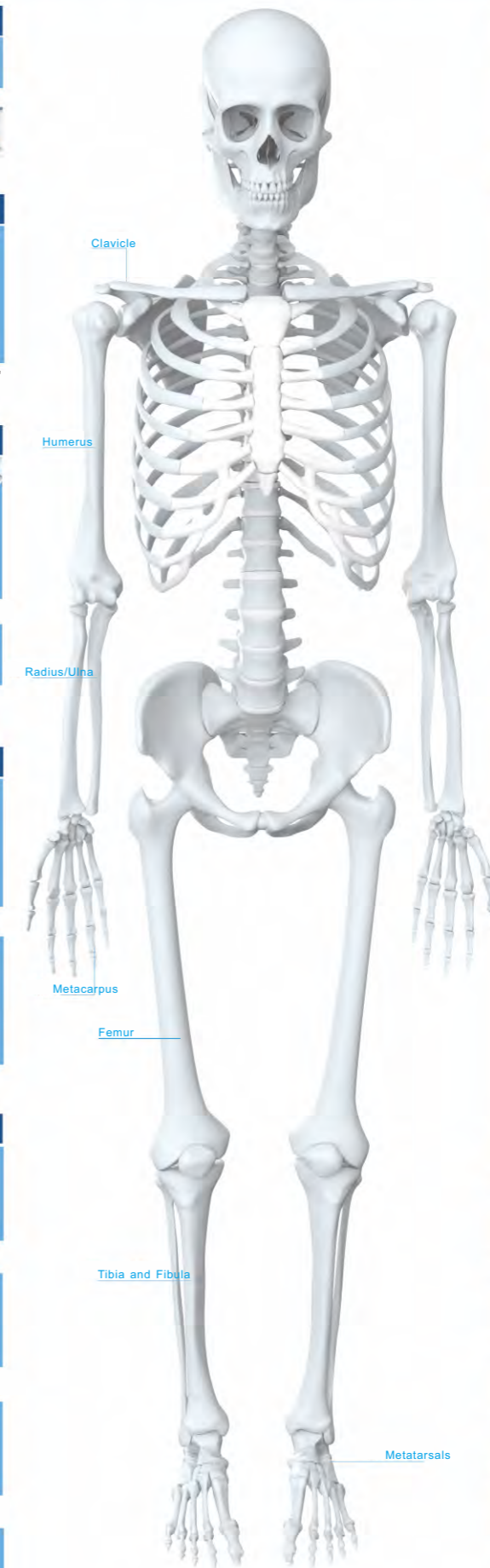

## Spine



## Mini Fragment Plating System

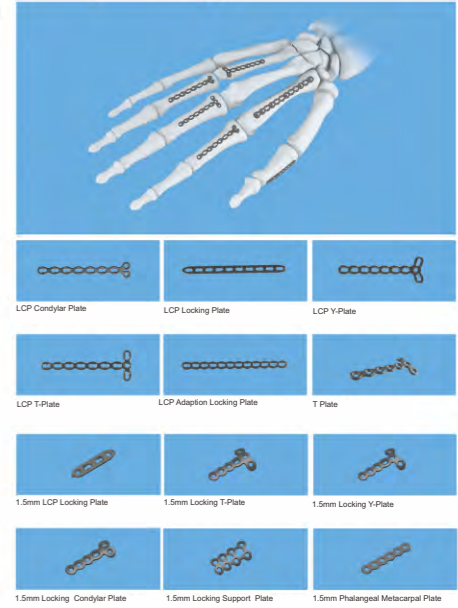

## Screws

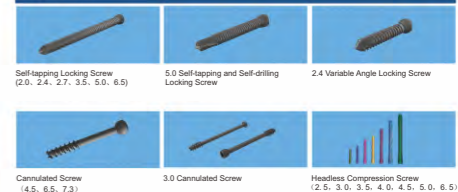

Mini Locking Plating System CanMLP .....	01	CanVKP Instrument Set .....	29
Φ2.4 Φ2.7 Locking Screw Instrument Set .....	02	Pelvic Reconstruction System CanPRS .....	30
Small Fragment Plating System Instrument Set CanSFP/SLP .....	03	Sternoclavicular Hook System CanSHS .....	31
Small Fragment Plating Basic Instrument Set CanSFP/SLP .....	04	Screw Extraction Instrument Set CanSES .....	32
Large Fragment Plating System Instrument Set CanLFP/LLP .....	05	Less Invasive Stabilization System Instrument Set CanLISS .....	33
Large Fragment Plating Basic Instrument Set CanLFP/LLP .....	06	Dynamic Hip and Condylar System CanDHS/CanDCS .....	34
Trauma Universal Instrument Set .....	07	Pelvic C-Clamp Instrument Set CanPCC .....	35
HB3.0 Cannulated Screw System CanNUS .....	08	Elastic Nail Instruments set .....	36
HB4.0 Cannulated Screw System CanNUS .....	09	Anterior Cervical Plating System CanACP .....	37
HB4.5 Cannulated Screw System CanNUS .....	10	Anterior Cervical Plating System CanACCESS .....	38
HB6.5/7.3 Cannulated Screw System CanNUS .....	11	Anterior Cervical Plating System CanACE .....	39
Headless Cannulated Screw Instrument Set (2.5/3.0/4.0) .....	12	Posterior Thoracolumbar System CanFIX .....	40
Headless Cannulated Screw Instrument Set (5.0/6.5) .....	13	Posterior Thoracolumbar Universal Instruments Set .....	41
Headless Cannulated Screw Basic Instrument Set CanCCS2.5 .....	14	Posterior Thoracolumbar System CanART .....	42
Headless Cannulated Screw Basic Instrument Set CanCCS3.0 .....	14	CanTSP5.5 Instruments Set .....	43
Headless Cannulated Screw Basic Instrument Set CanCCS3.5 .....	15	CanTSP5.5 Instruments Set For Correction .....	44
Headless Cannulated Screw Basic Instrument Set CanCCS4.0 .....	15	Posterior Thoracolumbar Fixation System CanTLF .....	45
Headless Cannulated Screw Basic Instrument Set CanCCS4.5 .....	16	Posterior Lumbar Interbody Fusion System CanPEEK-P .....	46
Headless Cannulated Screw Basic Instrument Set CanCCS5.0 .....	16	Transforaminal Lumbar Interbody Fusion System CanPEEK-T .....	47
Headless Cannulated Screw Basic Instrument Set CanCCS6.5 .....	17	Anterior Cervical Interbody Fusion System CanPEEK-C .....	48
Proximal Femoral Nail System CanPFN .....	18-19	Posterior Lumbar Interbody Fusion System CanPEEK-V .....	49
Proximal Femoral Nail System CanPFN II .....	20-21	Lateral Lumbar Interbody Fusion System CanPEEK-L .....	50
Proximal Femoral Nail System CanPFN (For Lag Screw) .....	22	Spine Minimally Invasive Channel System CanMIC .....	51
Proximal Femoral Nail System CanEFN .....	23-24	Lateral Spine Minimally Invasive Channel System CanMIC-L .....	52
Tibia Nail System CanETN .....	25	Posterior Thoracolumbar Fixation System Instrument Set CanPSS .....	53
Tibia Nail System CanTN .....	26	CanPSS - Lifting Instrument Set .....	54
Dynamic Reaming Instrument Set .....	27	Posterior Thoracolumbar Fixation System CanHELP .....	55
Foot&Ankle Reconstruction Locking Plate System CanFAR .....	28		

Mini Locking Plating System CanMLP

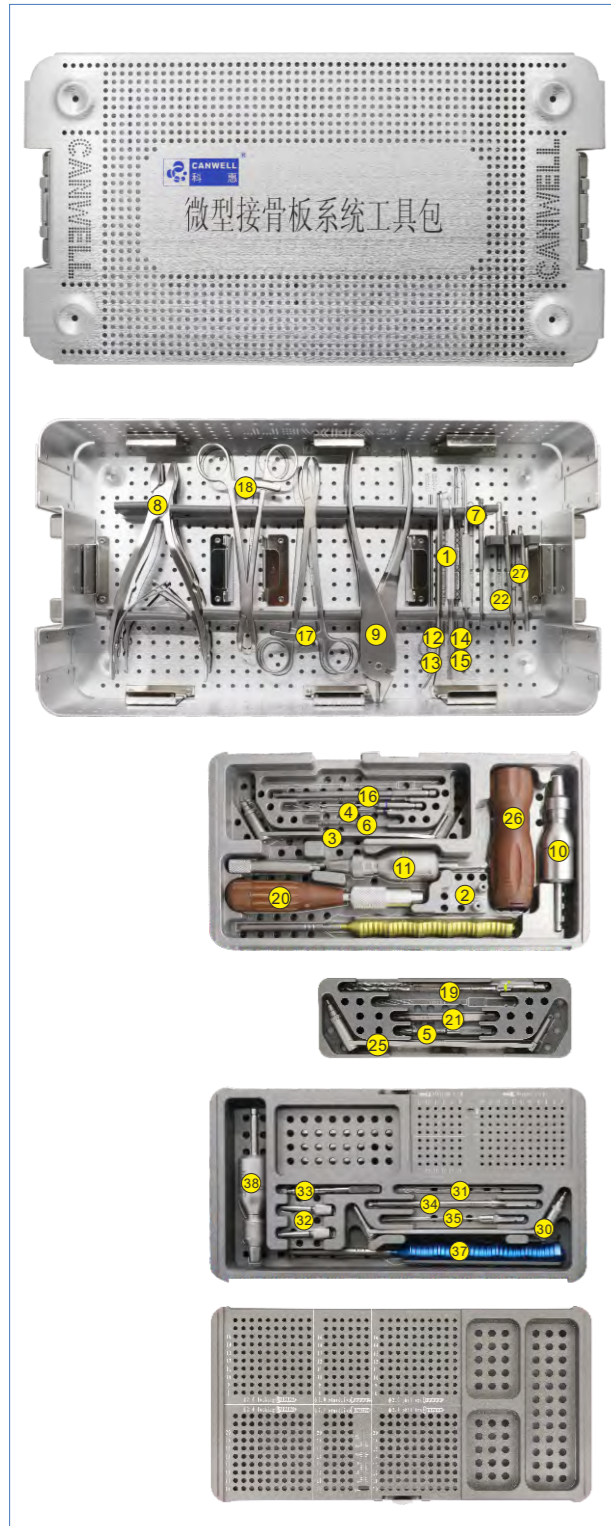

NO.	P.N	Description	Qty.
1	113200021	Sharp hook	1
2	111210002	LCP Drill Sleeve2.0	2
3	111210003	Drill Sleeve 2.0	1
4	111210004	Drill Bit (Φ1.5)	2
5	111210006	Countersink	1
6	111210007	Stardrive screwdriver-2.0	1
7	111210008	Stardrive screwdriver shaft-2.0	1
8	111210012	Flat Pliers	2
9	111210013	Cutting Pliers	1
10	111210014	Torque Limiter 0.4Nm	1
11	111210022	Torque Limiter 0.6Nm	1
12	111210023	Retractor (small)	1
13	111210024	Retractor (large)	1
14	111210026	Periosteal Elevator(small)	1
15	111210027	Periosteal Elevator(large)	1
16	111110007	Phillips Screwdriver Shaft	2
17	111110008	Reduction Forceps, with point	1
18	111110009	Reduction Forceps, with serrated jaws	1
19	112300002	Φ1.8 Drill Bit	2
20	112300004	Straight Handle with Quick Coupling	1
21	112300005	Stardrive Screwdriver(short)	1
22	112300006	Stardrive Screwdriver(long)	1
23	112300008	Depth Gauge	1
24	112300009	Φ1.8 LCP Drill Sleeve	2
25	112300010	Universal Drill Guide	1
26	112300011	Quick Coupling Straight Handle	1
27	111210031	LCP Plate Bender	2
28	111219400	Special Instrument Tray	1
29	111219500	Implant Tray	1
30	111219600	Instrument Tray(CanMLP)	1
31	111210035	Drill Sleeve Φ1.1/1.5	1
32	111210036	Φ1.1 Drill Bit	2
33	111210037	Φ1.1 Drill Sleeve	2
34	111210038	Phillips Screwdriver(long)	1
35	111210039	Phillips Screwdriver(short)	1
36	111210040	Tap	1
37	111210041	Depth Gauge	1
38	111210042	Torque Limiter 0.3Nm	1
39	111219800	Special Instrument Tray(Φ1.5)	1

Φ2.4 Φ2.7 Locking Screw Instrument Set

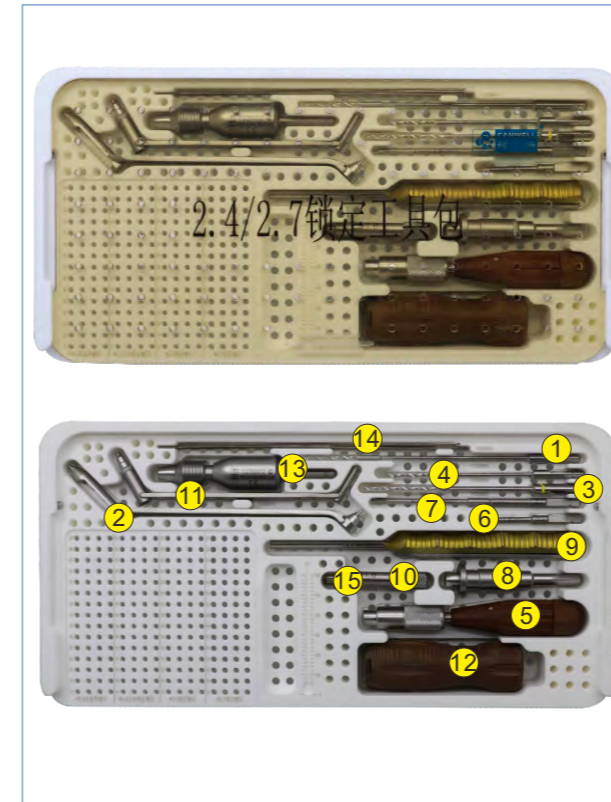

NO.	P.N	Description	Qty.
1	112300015	Φ2.0 Drill Bit	1
2	112300001	Φ1.8-φ2.4 Drill Sleeve	1
3	112300002	Φ1.8 Drill Bit	2
4	112300003	Φ2.0 Drill Bit	1
5	112300004	Straight Handle with Quick Coupling	1
6	112300005	Stardrive Screwdriver(short)	1
7	112300006	Stardrive Screwdriver(long)	1
8	112300007	Holding Sleeve	1
9	112300008	Depth Gauge	1
10	112300009	Φ1.8 LCP Drill Sleeve	1
11	112300010	Universal Drill Guide	1
12	112300011	Quick Coupling Handle	1
13	112300012	Torque Limited Head	1
14	112300013	Guide Wire	4
15	112300014	Φ2.0 LCP Drill Sleeve	1
16	112308000	Instruments Tray	1

Small Fragment Plating System Instrument Set CanSFP/SLP

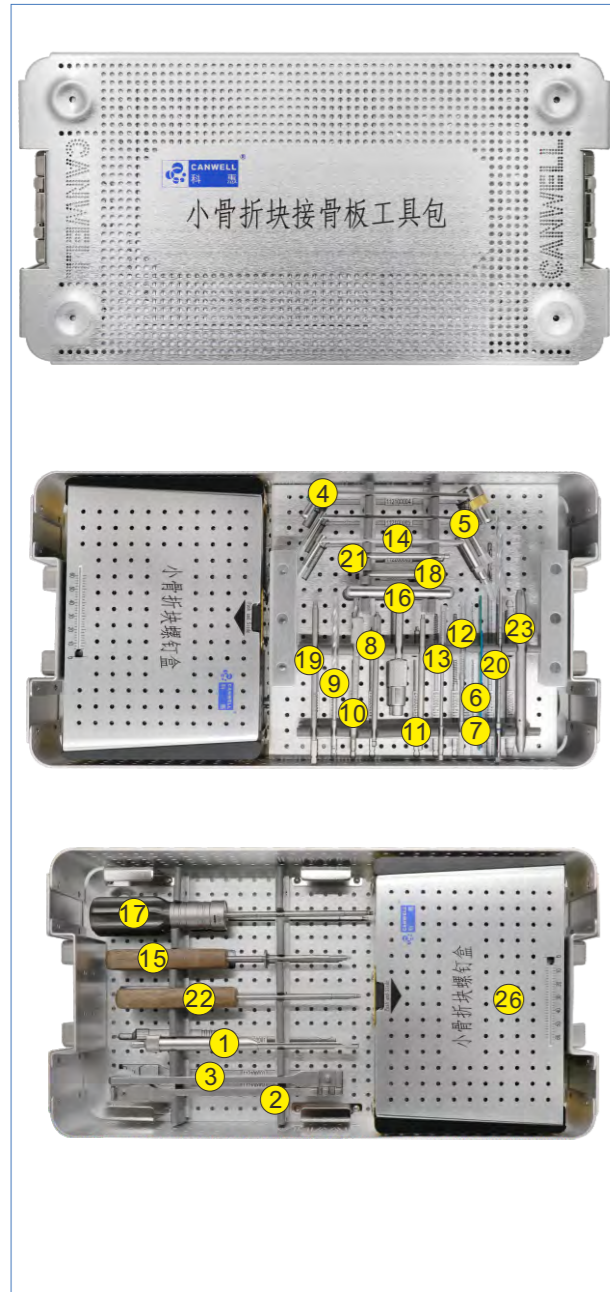

NO.	P.N	Description	Qty.
1	112100001	Depth Gauge for $\Phi 2.5\text{mm}-\Phi 4.0\text{mm}$ Length 60mm	1
2	112100002	Plate Bender, left Length 190mm	1
3	112100003	Plate Bender, right Length 190mm	1
4	112100004	LC-DCP Drill Guide, $\Phi 2.5/\Phi 3.5\text{mm}$	1
5	112100005	Double Drill Sleeve I, $\Phi 2.5/\Phi 3.5\text{mm}$	1
6	112100008	Bending Template, large Length 118mm Width 10mm	1
7	112100009	Bending Template, small Length 92mm Width 10mm	1
8	112100014	Countersink Length 100mm	1
9	112100015	Drill Bit, $\Phi 3.5\text{mm}$ Length 112mm Thread Length 60mm	1
10	112100016	Drill Bit, $\Phi 2.5\text{mm}$ Length 112mm Thread Length 30mm	2
11	112100017	Hexagonal Screwdriver Shaft	1
12	112100018	Tap for Cortex Screw $\Phi 3.5\text{mm}$ Length 112mm Thread Length 30mm	1
13	112100019	Tap for Cancellous Bone Screw $\Phi 4.0\text{mm}$ Thread Length 20mm	1
14	112100020	Universal Drill Guide II, $\Phi 3.5/2.5\text{mm}$	1
15	112100022	Hexagonal Screwdriver with Holding Sleeve, Length 200mm	1
16	112100024	T-handle with Quick Coupling Length 90mm	1
17	112200001	Torque Limiter 1.5N Length 220mm	1
18	112200002	$\Phi 2.8$ Threaded Drill Sleeve for $\Phi 3.5\text{mm}$	2
19	112200003	Stardrive Screwdriver Shaft, Length 120mm	1
20	112200004	$\Phi 2.8$ Drill Bit Length 165mm Thread Length 40mm	2
21	112200005	Easyout Length 80mm	1
22	112200009	Screw Driver Length 200mm	1
23	112200010	Bender for K-Wire	1
24	112127000	Screw Tray	1
25	112128000	Instrument Tray	1
26	112200013	Extended Drill Bit, $\Phi 2.8\text{mm}$	1
27	112200014	Extended Threaded Drill Sleeve	1

Small Fragment Plating Basic Instrument Set CanSFP/SLP

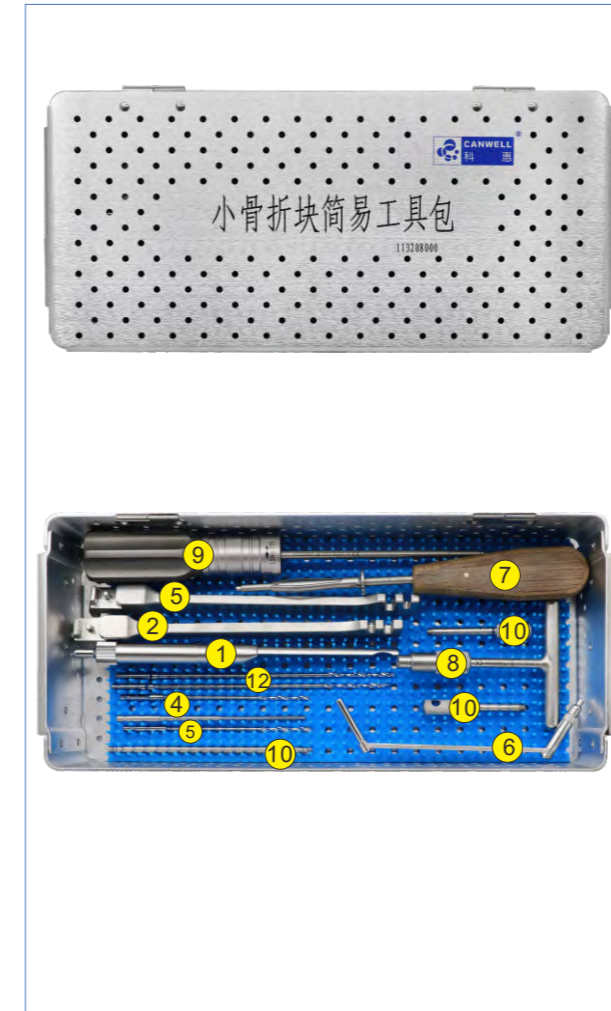

No.	P.N	Description	Qty.
1	112100001	Depth Gauge for $\Phi 2.5\text{mm}-\Phi 4.0\text{mm}$ Length 60mm	1
2	112100002	Plate Bender, left Length 190mm	1
3	112100003	Plate Bender, right Length 190mm	1
4	112100016	Drill Bit, $\Phi 2.5\text{mm}$ Length 112mm Thread Length 30mm	2
5	112100018	Tap for Cortex Screw $\Phi 3.5\text{mm}$ Length 112mm Thread Length 30mm	1
6	112100020	Universal Drill Guide II, $\Phi 3.5/2.5\text{mm}$	1
7	112100022	Hexagonal Screwdriver with Holding Sleeve, Length 200mm	1
8	112100024	T-handle with Quick Coupling Length 90mm	1
9	112200001	Torque Limiter 1.5N Length 220mm	1
10	112200002	$\Phi 2.8$ Threaded Drill Sleeve for $\Phi 3.5\text{mm}$	2
11	112200003	Stardrive Screwdriver Shaft, Length 120mm	1
12	112200004	$\Phi 2.8$ Drill Bit Length 165mm Thread Length 40mm	2
13	112107000	Screw Tray	1
14	113207000	Instrument Set	1

Large Fragment Plating System Instrument Set CanLFP/LLP

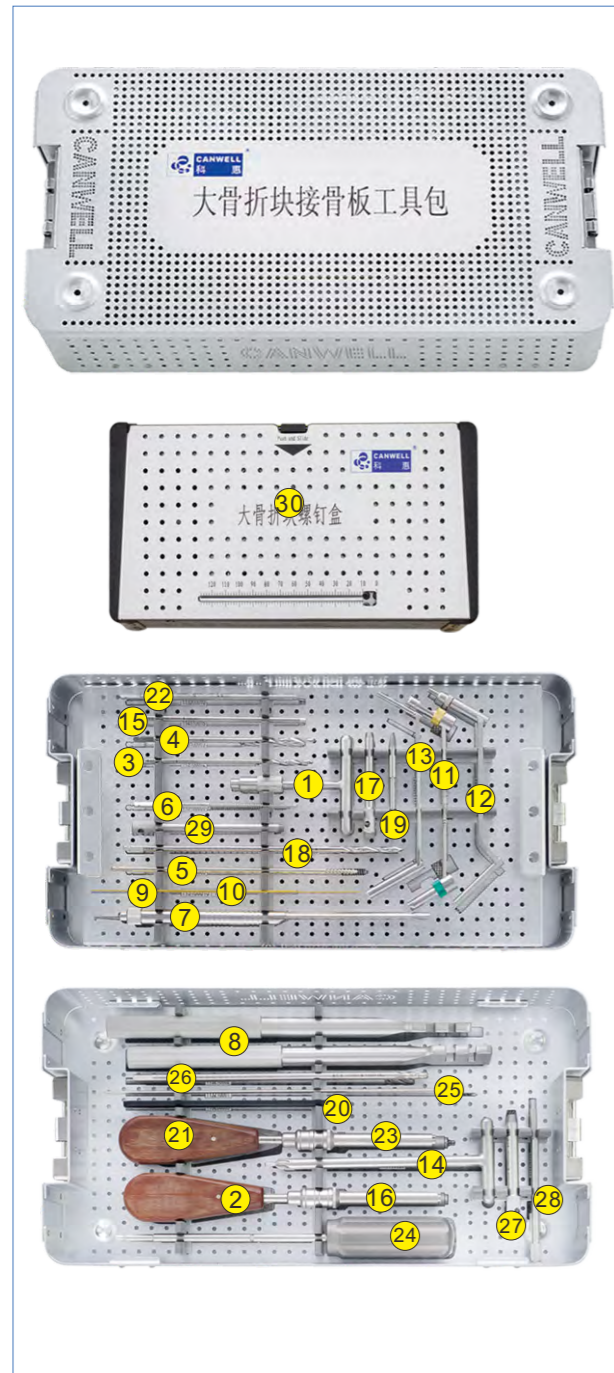

NO.	P.N	Description	Qty.
1	112100024	T-handle with Quick Coupling Length 90mm	1
2	113100001	Hexagonal Screwdriver, Length 248mm	1
3	113100002	Drill Bit, Φ3.2mm Length 147mm Thread Length 40mm	2
4	113100003	Drill Bit, Φ4.5mm Length 145mm Thread Length 48mm	1
5	113100005	Tap for Cancellous Bone Screw Φ6.5mm Length 195mm Thread Length 26mm	1
6	113100006	Tap for Cortex Screw Φ4.5mm Length 130mm Thread Length 70mm	1
7	113100007	Depth Gauge for screws Φ4.5/Φ6.5mm Length 110mm	1
8	113100008	Plate Bender Length 285mm	2
9	113100010	Bending Template, large Length 212mm Width 12mm	1
10	113100011	Bending Template, small Length 121mm Width 12mm	1
11	113100012	Double Drill Guide Φ3.2mm	1
12	113100014	Universal Drill Guide, Φ4.5/3.2mm	1
13	113100015	Universal Drill Guide, Φ6.5/3.2mm	1
14	113100020	Countersink Length 180mm	1
15	114110015	Screwdriver shaft with quick coupling, hexagonal Length 100mm SW3.5	1
16	114400007	Holding Sleeve, Φ8mm Length 120mm	1
17	113200002	Φ4.3mm Threaded Drill Sleeve	2
18	113200003	Φ4.3mm Drill Bit Length 220mm Thread Length 84mm	2
19	113200004	Easyout Length 80mm	1
20	113200005	Direct Measuring Device	1
21	113200009	Screw Driver Length 248mm	1
22	113200010	Stardrive screwdriver shaft Length 145mm	1
23	113200011	Holding SleeveΦ6.3	1
24	113200038	Torque Limiter 4.5N	1
25	113210001	Φ2.5 K-Wire	3
26	113210002	Φ5.8 Cannulated drill bit	2
27	113210004	Φ5.8mm Cannulated drill sleeve	2
28	113210005	Guide for K-Wire Φ2.5mm	2
29	113200036	Φ4.3 Threaded Drill Sleeve (long)	1
30	113106000	Screws Tray	1
31	113127000	Instrument Tray	1

Large Fragment Plating Basic Instrument Set CanLFP/LLP

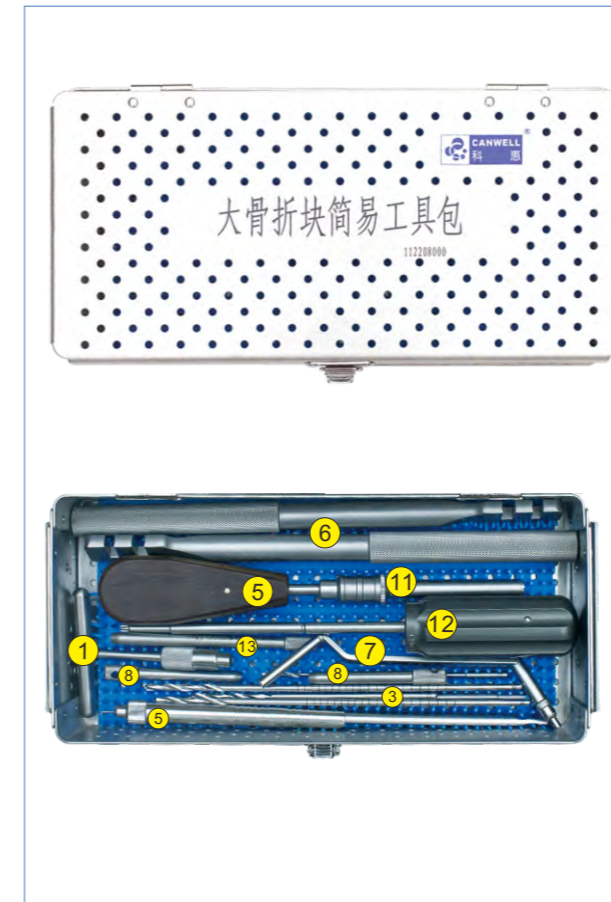

NO.	P.N	Description	Qty.
1	112100024	T-handle with Quick Coupling Length 90mm	1
2	113100001	Hexagonal Screwdriver, Length 248mm	1
3	113100002	Drill Bit, Φ3.2mm Length 147mm Thread Length 40mm	2
4	113100006	Tap for Cortex Screw Φ4.5mm Length 130mm Thread Length 70mm	1
5	113100007	Depth Gauge for screws Φ4.5/Φ6.5mm Length 110mm	1
6	113100008	Plate Bender Length 285mm	2
7	113100014	Universal Drill Guide, Φ4.5/3.2mm	1
8	113200002	Φ4.3mm Threaded Drill Sleeve	2
9	113200003	Φ4.3mm Drill Bit Length 220mm Thread Length 84mm	2
10	113200010	Stardrive screwdriver shaft Length 145mm	1
11	113200011	Holding SleeveΦ6.3	1
12	113200038	Torque Limiter 4.5N	1
13	113200036	Φ4.3 Threaded Drill Sleeve (long)	1
14	113105000	Screws Tray	1
15	112207000	Instrument Tray	1

Trauma Universal Instrument Set

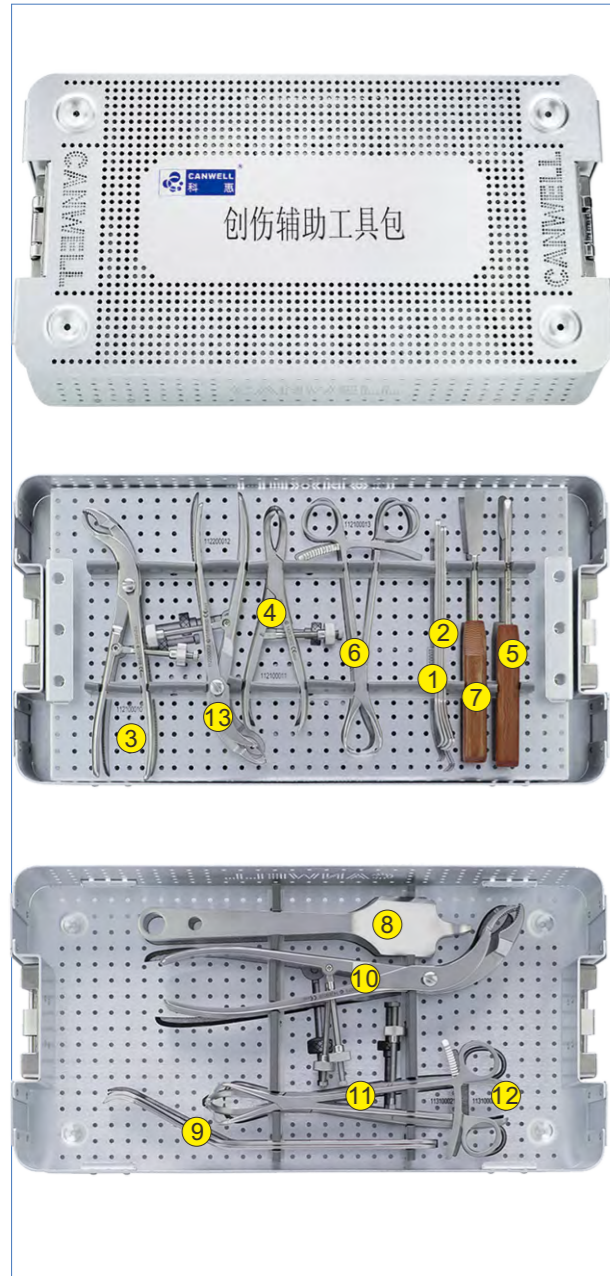

NO.	P.N	Description	Qty.
1	112100006	Hohmann Retractor,large Length 159mm Width 15.5mm	2
2	112100007	Hohmann Retractor, small Length 170mm Width 10.5mm	2
3	112100010	Self-Centering Bone Holding Forceps, speed lock Length 191.8mm	1
4	112100011	Reduction Forceps, with serrated jaws Length 158mm	1
5	112100012	Periosteal Elevator,small Length 190mm	1
6	112100013	Reduction Forceps, with points Length 182mm	1
7	113100016	Periosteal Elevator,large Length 191mm	1
8	113100017	Hohmann Retractor, large Length 267mm Width 43.5mm	2
9	113100018	Hohmann Retractor, small Length 267mm Width 16mm	2
10	113100019	Self-Centering Bone Holding Forceps, speed lock Length 266mm	2
11	113100021	Reduction Forceps, with serrated jaws Length 220mm	1
12	113100022	Reduction Forceps, with point Length 207mm	1
13	112200012	Self-Centering Bone Holding Forceps(compression)	1
14	113122000	Instrument Tray	1

HB3.0 Cannulated Screw System CanNUS

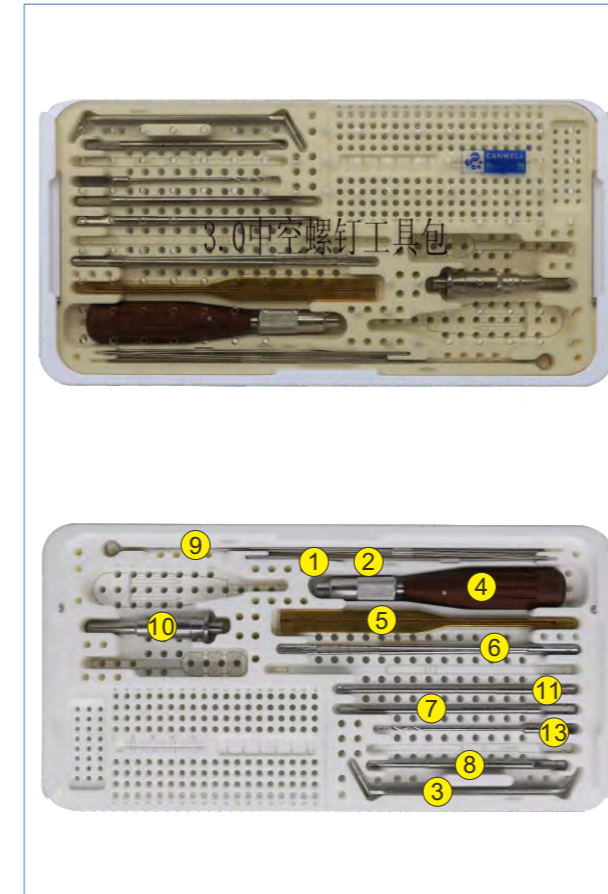

NO.	P.N	Description	Qty.
1	114500001	Kirschner (Φ1.1)	4
2	114500002	K-Wire with Threaded Tip (Φ1.1)	4
3	114500003	Drill Sleeve(1.1/2.0)	1
4	114500004	Cannulated T-handle with Quick Coupling	1
5	114500005	Depth Gauge	1
6	114500006	Cannulated drill bit	2
7	114500007	Countersink	1
8	114500009	Phillips Solid Screwdriver	1
9	114500010	Cleaning Wire	1
10	114500011	Screw Holder	1
11	114500008	Cannulated Phillips Screwdriver	1
12	114502000	Instruments tray	1
13	112300003	Φ2.0 Drill Bit	1

HB4.0 Cannulated Screw System CanNUS

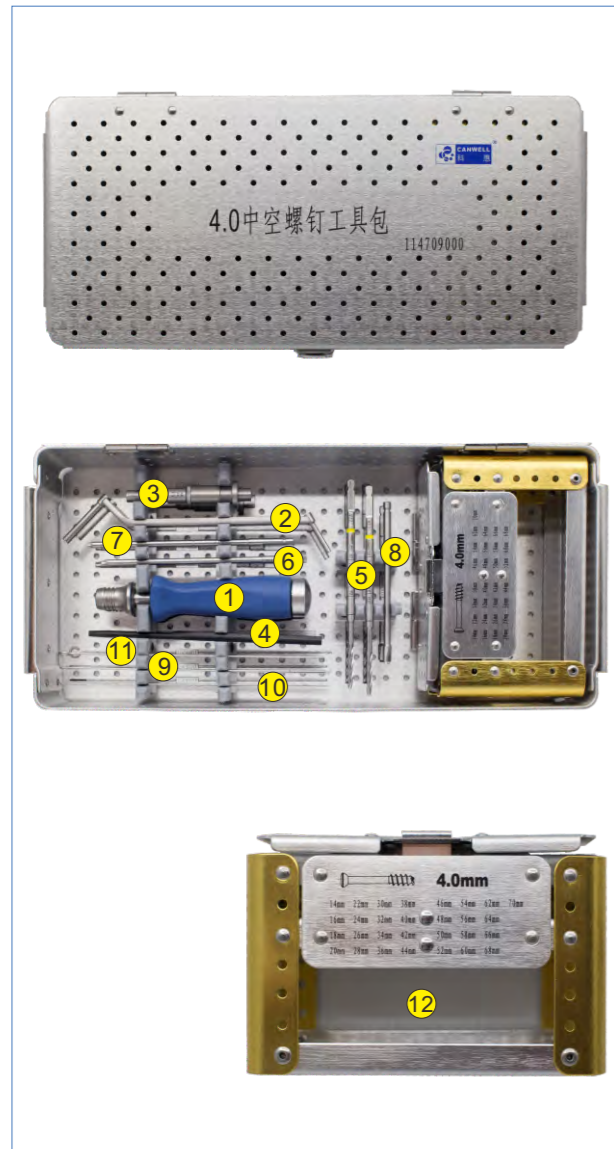

NO.	P.N	Description	Qty.
1	114600025	Quick Coupling Handle	1
2	114700001	Drill Guide	1
3	114700002	Holding Sleeve	1
4	114700003	Depth Gauge	1
5	114700004	Drill Bit	2
6	114700005	Screwdriver	1
7	114700006	Screwdriver	1
8	114700007	Countersink	1
9	114700008	Guide Wire	4
10	114700009	Guide Wire With Thread	4
11	114700010	Probe	1
12	114702000	Implant Tray	1
13	114711000	Instrument Tray	1

HB4.5 Cannulated Screw System CanNUS

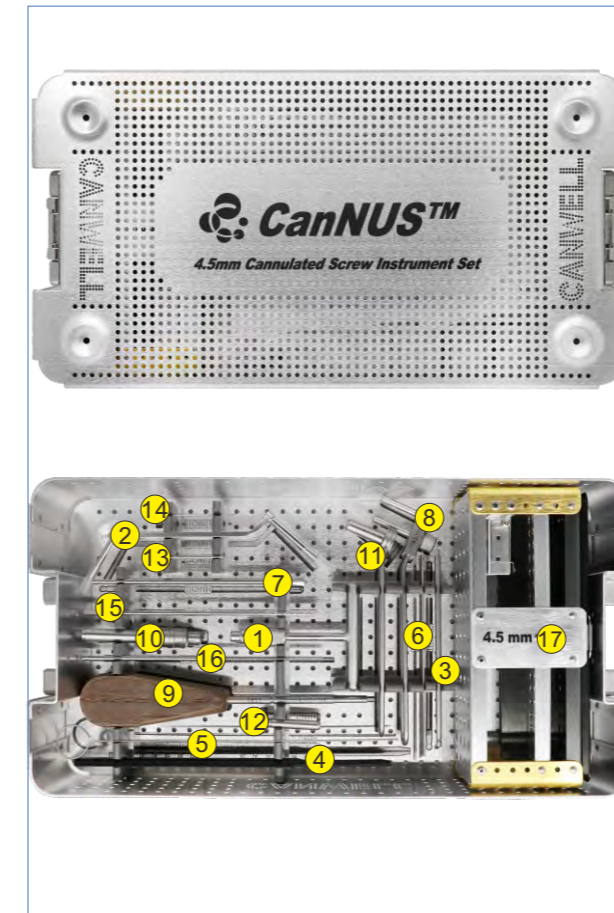

NO.	P.N	Description	Qty.
1	112100024	T-handle with Quick Coupling Length 90mm	1
2	113100013	Universal Drill Guide $\Phi$ 4.5/3.2mm,	1
3	114110015	Screwdriver shaft with quick coupling, hexagonal Length 100mm SW3.5	1
4	114200001	Depth Gauge Length 150mm/230mm	1
5	114200002	$\Phi$ 1.6mm Cleaning Wire Length 240mm	1
6	114200003	$\Phi$ 1.6mm Kirschner Wire Length 150mm Thread Length 11mm	10
7	114200004	Countersink Drill Bit Length 160mm	1
8	114200005	Parallel Locator $\Phi$ 1.6mm	1
9	114200006	SW3.5 Hexagonal Screwdriver	1
10	114200007	$\Phi$ 6.5 Holding Sleeve Length 89mm	1
11	114200008	$\Phi$ 9.5/ $\Phi$ 7.0Locator Length 39mm	1
12	114200009	$\Phi$ 7.0/ $\Phi$ 3.2Drill bushing Length 46mm	1
13	114200010	$\Phi$ 3.2/ $\Phi$ 1.6Drill bushing Length 52mm	1
14	114200011	$\Phi$ 1.6Trocar Length 58.8mm	1
15	114200012	$\Phi$ 3.2Cannulated Drill Bit Length 170mm	1
16	114200014	Cannulated Tap for Cancellous Bone screw $\phi$ 4.5mm Length 180mm Thread Length 80mm	1
17	114202000	Screw Tray	1
18	114204000	Instrument Tray( CanNUS-4.5)	1



HB6.5/7.3 Cannulated Screw System CanNUS

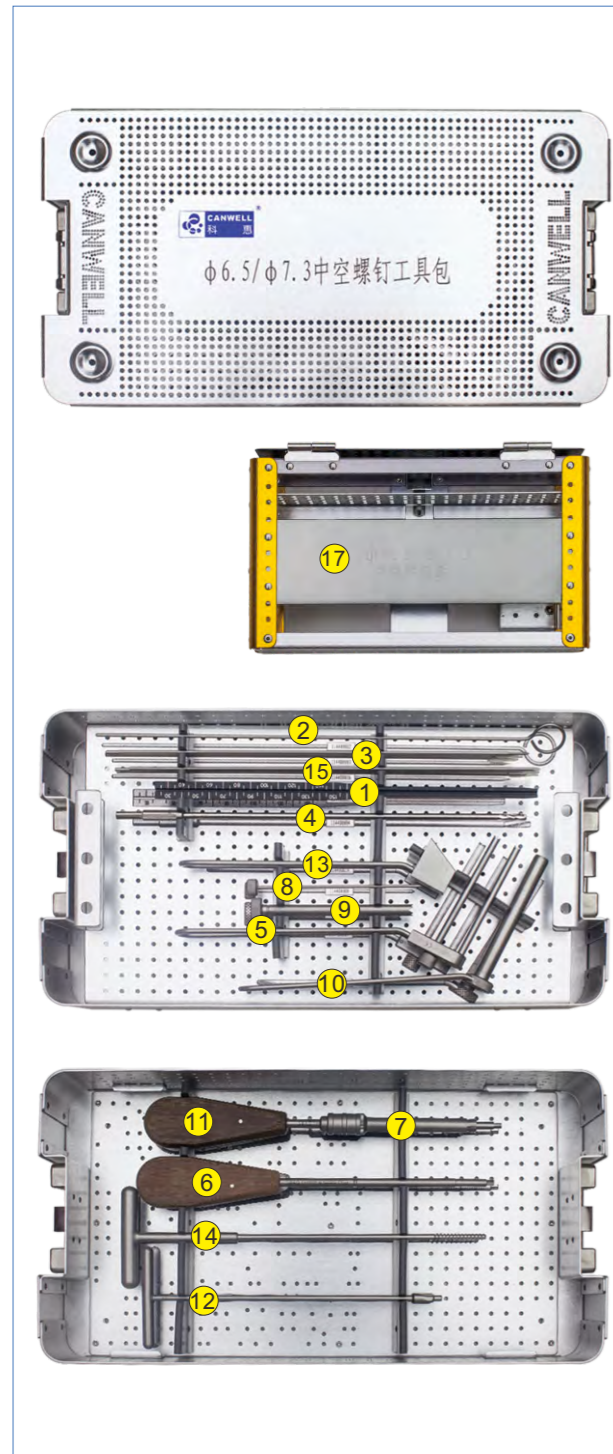

NO.	P.N	Description	Qty.
1	114400001	Depth Gauge Length 330mm	1
2	114400002	Φ2.5mm Cleaning Wire Length 330mm	1
3	114400003	Φ2.5mm Kirschner wire Length 300mm Thread Length 15mm	10
4	114400004	Φ5mm Drill Bit Length 300mm	1
5	114400005	Parallel Locator	1
6	114400006	SW4.0Hexagonal Screwdriver Length 248mm	1
7	114400007	Holding Sleeve, Φ8mm Length 120mm	1
8	114400008	Φ2.5mm Trochar Length 128mm	1
9	114400009	Φ8.5/Φ2.5Drill Bushing Length 118mm	1
10	114400010	Φ12/Φ8.5Protective Sleeve Length 108mm	1
11	114400011	Hexagonal Solid Screwdriver Length 248mm	1
12	114400012	Φ8Tubular Countersink Drill Length 230mm	1
13	114400014	Adjustable Parallel Drill GuideΦ2.5mm	1
14	114400015	Tap for Cancellous Bone Tubular Screw Length 280mm Thread Length 40mm	1
15	114402000	Screw Tray HB6.5	1
16	114403000	Screw Tray HB7.5	1
17	114404000	Instrument Tray( CanNUS-6.5/7.3)	1

Headless Cannulated Screw Instrument Set (2.5/3.0/4.0)

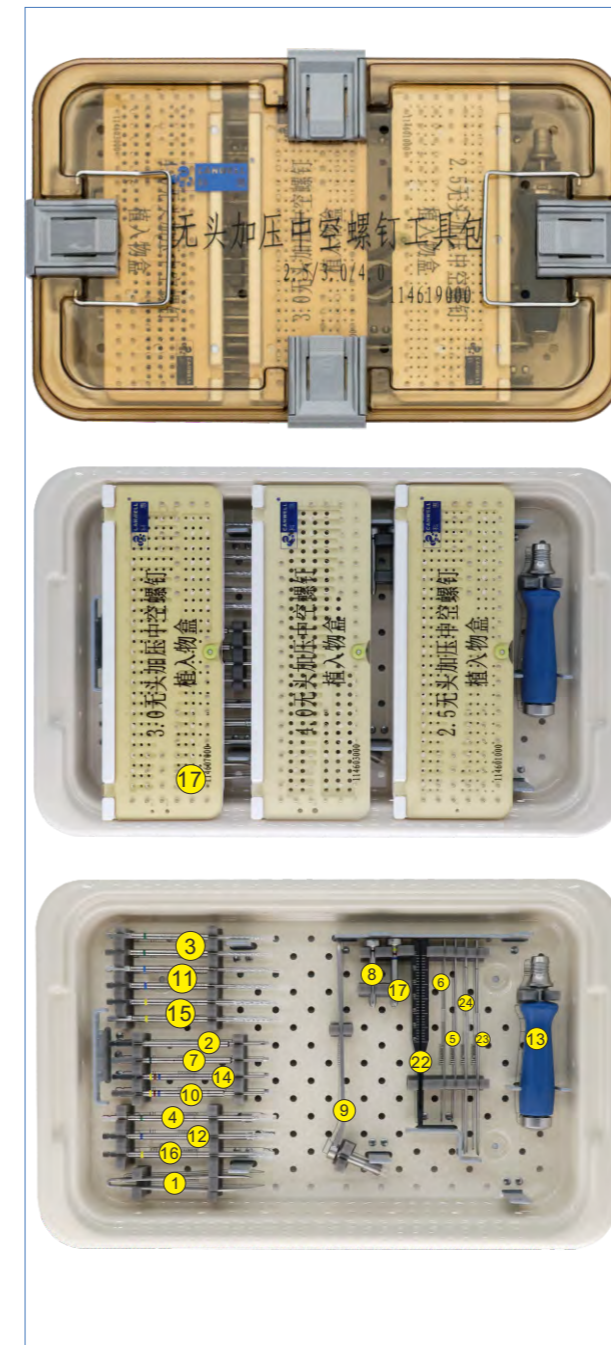

NO.	P.N	Description	Qty.
1	114600005	Screw Holder	1
2	114600011	Screwdriver,SW1.5	1
3	114600012	Φ1.9mm,Drill bit	2
4	114600013	Φ2.5mm,Countersink	1
5	114600015	Φ0.9mm,Guide wire	4
6	114600016	Φ0.9mm,Guide Wire With Thread	4
7	114600017	Screwdriver,Cannulated,SW1.5	1
8	114600018	Sheath	1
9	114600019	Drill Guide	1
10	114600020	Screwdriver,T8	1
11	114600022	Φ2.3mm,Drill bit	2
12	114600023	Φ3.0mm,Countersink	1
13	114600025	Quick Coupling Handle	1
14	114600031	Screwdriver,Cannulated,T8	1
15	114600037	Φ3.2mm,Drill bit	2
16	114600038	Φ4.0mm,Countersink	1
17	114600039	Φ1.1mm,Sleeve	1
18	114621000	Φ2.5mm,Implant Tray	1
19	114623000	Φ4.0mm,Implant Tray	1
20	114627000	Φ3.0mm,Implant Tray	1
21	114631000	Instrument Tray	1
22	114700003	Depth Gauge	1
23	114700008	Φ1.1mm,Guide Wire	6
24	114700009	Φ1.1mm,Guide Wire With Thread	6
25	114622000	Φ3.5mm,Implant Tray	1
26	114600032	Φ2.7mm,Drill Bit	2
27	114600033	Φ3.5mm,Countersink	1

Headless Cannulated Screw Instrument Set (5.0/6.5)

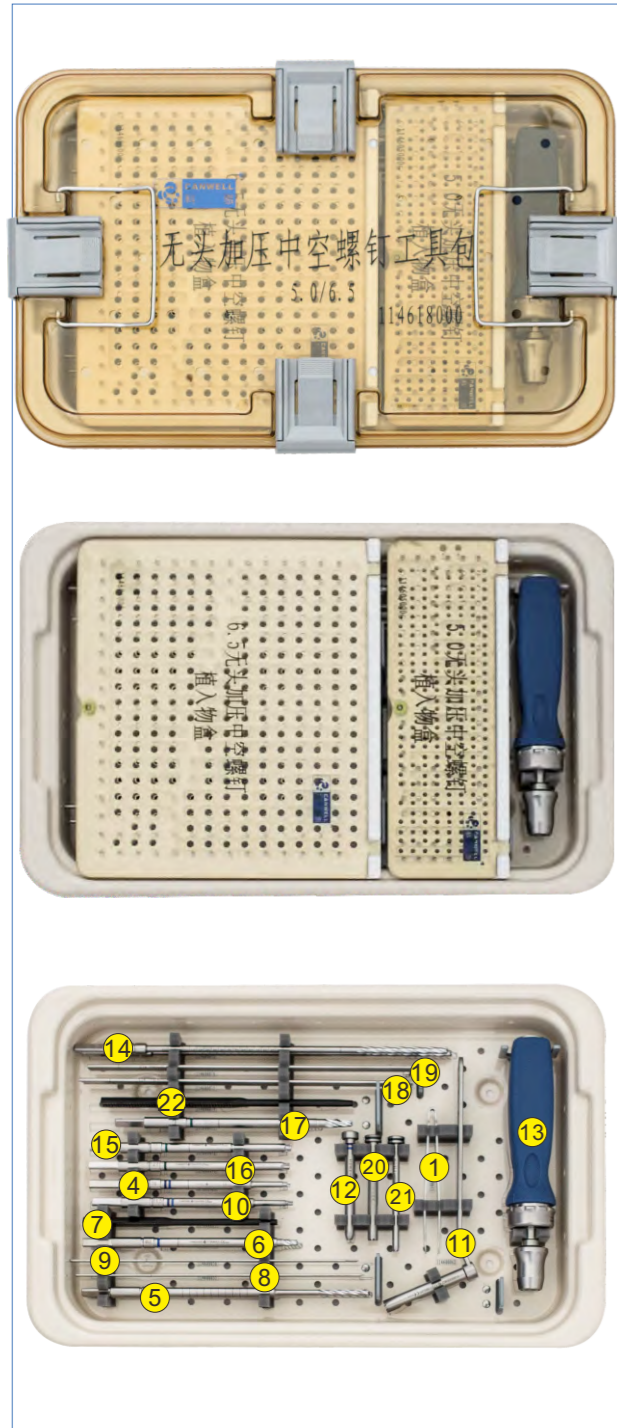

NO.	P.N	Description	Qty.
1	114600005	Screw Holder	1
2	114605000	Φ5.0mm, Implant Tray	1
3	114606000	Φ6.5mm, Implant Tray	1
4	114600051	Screwdriver, Cannulated, T15	1
5	114600052	Φ4.0mm, Drill bit	2
6	114600053	Φ5.0mm, Countersink	1
7	114600054	Depth Gauge, Length 60mm	1
8	114600055	Φ1.6mm, Guide Wire	4
9	114600056	Φ1.6mm, Guide Wire With Thread	4
10	114600060	Screwdriver, T15	1
11	114600062	Drill Guide	1
12	114600063	Φ1.6mm, Sleeve	1
13	114600065	Quick Coupling Handle	1
14	114600071	Φ5.0mm, Drill bit	2
15	114600072	Screwdriver, Cannulated, T27	1
16	114600073	Screwdriver, T27	1
17	114600074	Φ6.5mm, Countersink	1
18	114600075	Φ2.5mm, Guide Wire With Thread	4
19	114600076	Φ2.5mm, Guide Wire	4
20	114600077	Drill Guide	1
21	114600078	Φ2.5mm, Sleeve	1
22	114600079	Depth Gauge, Length 120mm	1
23	114632000	Instrument Tray	1
24	114624000	Φ4.5mm, Implant Tray	1
25	114600059	Φ3.3mm, Drill Bit	1
26	114600061	Φ4.5mm, Countersink	1

Headless Cannulated Screw Basic Instrument Set CanCCS2.5  
114619001

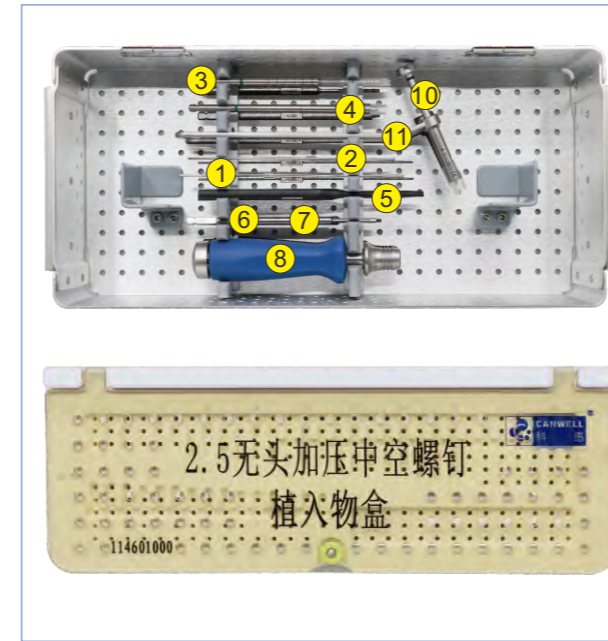

NO.	P.N	Description	Qty.
1	114600015	Φ0.9mm, Guide Wire	4
2	114600016	Φ0.9mm, Guide Wire With Thread	4
3	114600012	Φ1.9mm, Drill bit	2
4	114600013	Φ2.5mm, Countersink	1
5	114700003	Depth Gauge	1
6	114600011	Screwdriver, Cannulated, SW1.5	1
7	114600017	Screwdriver, SW1.5	1
8	114600025	Quick Coupling Handle	1
9	114621000	Φ2.5mm, Implant Tray	1
10	114600018	Sleeve	1
11	114600019	Drill Guide	1
12	114611002	Instrument Tray	1

Headless Cannulated Screw Basic Instrument Set CanCCS3.0  
114619005

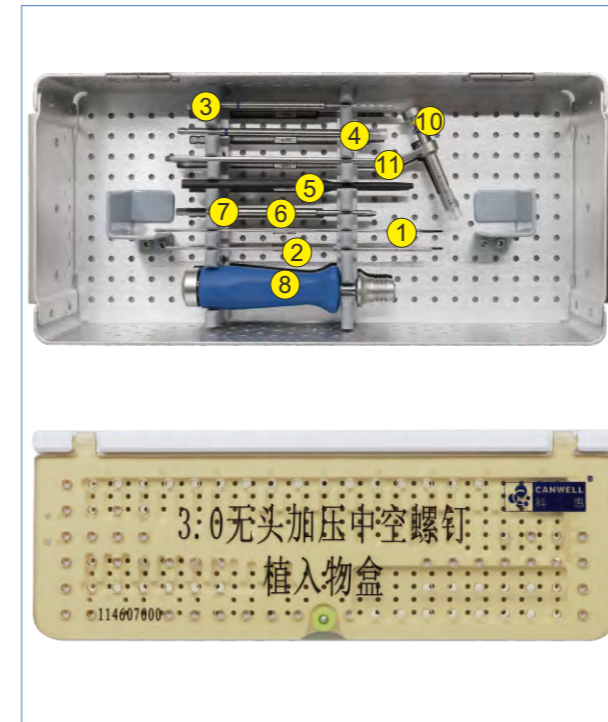

NO.	P.N	Description	Qty.
1	114700008	Φ1.1mm, Guide Wire	4
2	114700009	Φ1.1mm, Guide Wire With Thread	4
3	114600022	Φ2.3mm, Drill bit	2
4	114600023	Φ3.0mm, Countersink	1
5	114700003	Depth Gauge	1
6	114600031	Screwdriver, Cannulated, T8	1
7	114600020	Screwdriver, T8	1
8	114600025	Quick Coupling Handle	1
9	114627000	Φ3.0mm, Implant Tray	1
10	114600039	Sleeve	1
11	114600019	Drill Guide	1
12	114611004	Instrument Tray	1

Headless Cannulated Screw Basic Instrument Set CanCCS

Headless Cannulated Screw Basic Instrument Set CanCCS3.5  
114619006

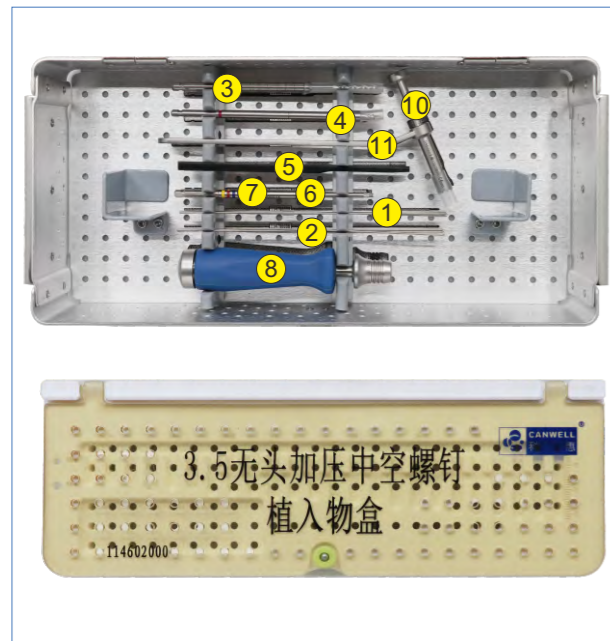

NO.	P.N	Description	Qty.
1	114700008	Φ1.1mm,Guide Wire	4
2	114700009	Φ1.1mm,Guide Wire With Thread	4
3	114600032	Φ2.7mm,Drill Bit	2
4	114600033	Φ3.5mm,Countersink	1
5	114700003	Depth Gauge	1
6	114600020	Screwdriver,T8	1
7	114600031	Screwdriver,Cannulated,T8	1
8	114600025	Quick Coupling Handle	1
9	114622000	Φ3.5mm,Implant Tray	1
10	114600039	Sleeve	1
11	114600019	Drill Guide	1
12	114611006	Instrument Tray	1

Headless Cannulated Screw Basic Instrument Set CanCCS4.5  
114619008

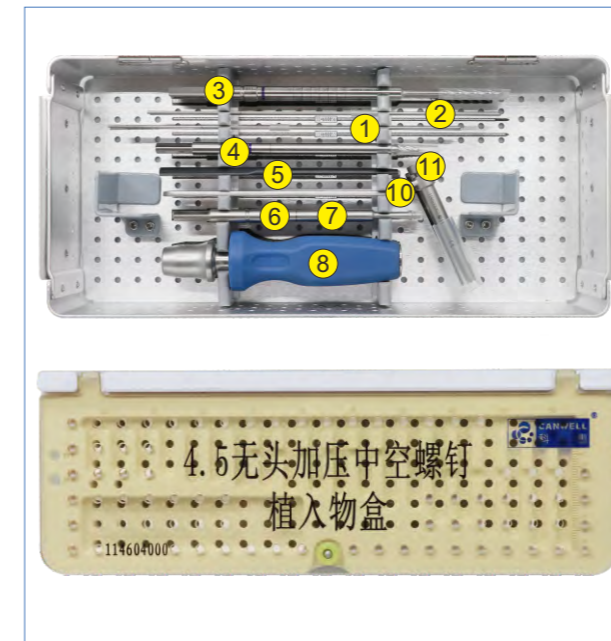

NO.	P.N	Description	Qty.
1	114600055	Φ1.6mm,Guide Wire	4
2	114600056	Φ1.6mm,Guide Wire With Thread	4
3	114600059	Φ3.3mm,Drill bit	2
4	114600061	Φ4.5mm,Countersink	1
5	114600054	Depth Gauge	1
6	114600051	Screwdriver,Cannulated,T15	1
7	114600060	Screwdriver,T15	1
8	114600065	Quick Coupling Handle	1
9	114624000	Φ4.5mm,Implant Tray	1
10	114600062	Drill Guide	1
11	114600063	Sleeve	1
12	114621002	Instrument Tray	1

Headless Cannulated Screw Basic Instrument Set CanCCS4.0  
114619007

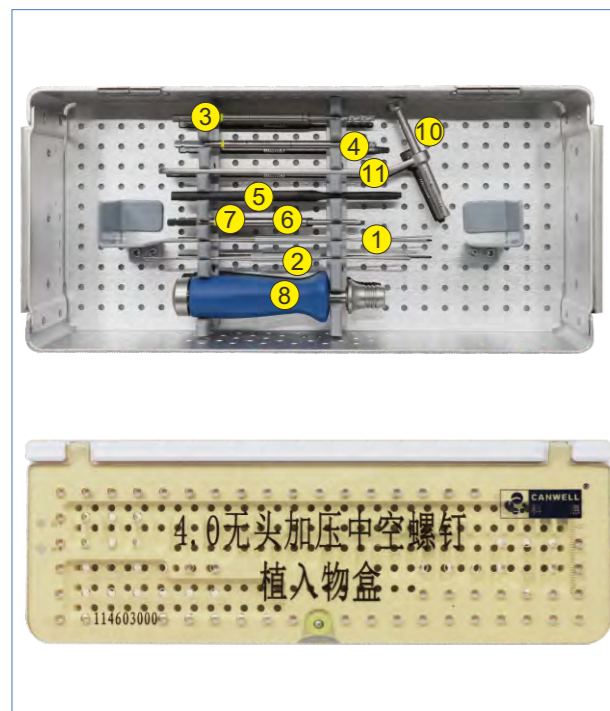

NO.	P.N	Description	Qty.
1	114700008	Φ1.1mm,Guide Wire	4
2	114700009	Φ1.1mm,Guide Wire With Thread	4
3	114600037	Φ3.2mm,Drill Bit	2
4	114600038	Φ4.0mm,Countersink	1
5	114700003	Depth Gauge	1
6	114600020	Screwdriver,T8	1
7	114600031	Screwdriver,Cannulated,T8	1
8	114600025	Quick Coupling Handle	1
9	114623000	Φ4.0mm,Implant Tray	1
10	114600039	Sleeve	1
11	114600019	Drill Guide	1
12	114611008	Instrument Tray	1

Headless Cannulated Screw Basic Instrument Set CanCCS5.0  
114619009

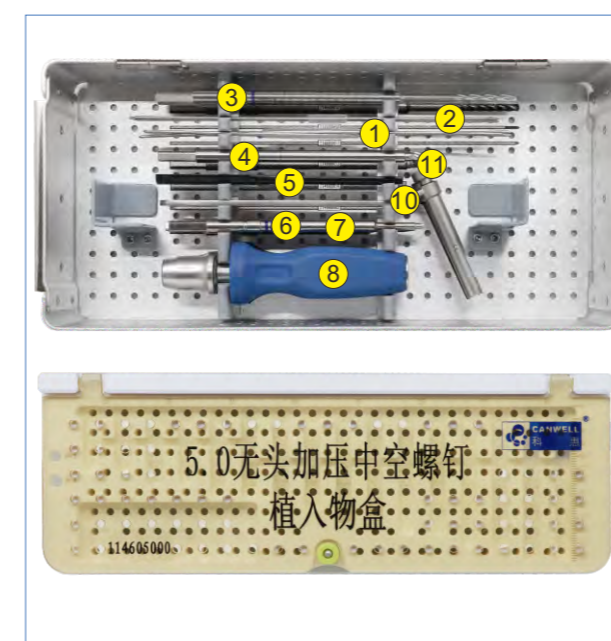

NO.	P.N	Description	Qty.
1	114600055	Φ1.6mm,Guide Wire	4
2	114600056	Φ1.6mm,Guide Wire With Thread	4
3	114600052	Φ4.0mm,Drill Bit	2
4	114600053	Φ5.0mm,Countersink	1
5	114600054	Depth Gauge	1
6	114600051	Screwdriver,Cannulated,T15	1
7	114600060	Screwdriver,T15	1
8	114600065	Quick Coupling Handle	1
9	114625000	Φ5.0mm,Implant Tray	1
10	114600062	Drill Guide	1
11	114600063	Sleeve	1
12	114621004	Instrument Tray	1

Headless Cannulated Screw Basic Instrument Set CanCCS

Headless Cannulated Screw Basic Instrument Set CanCCS6.5  
114618003

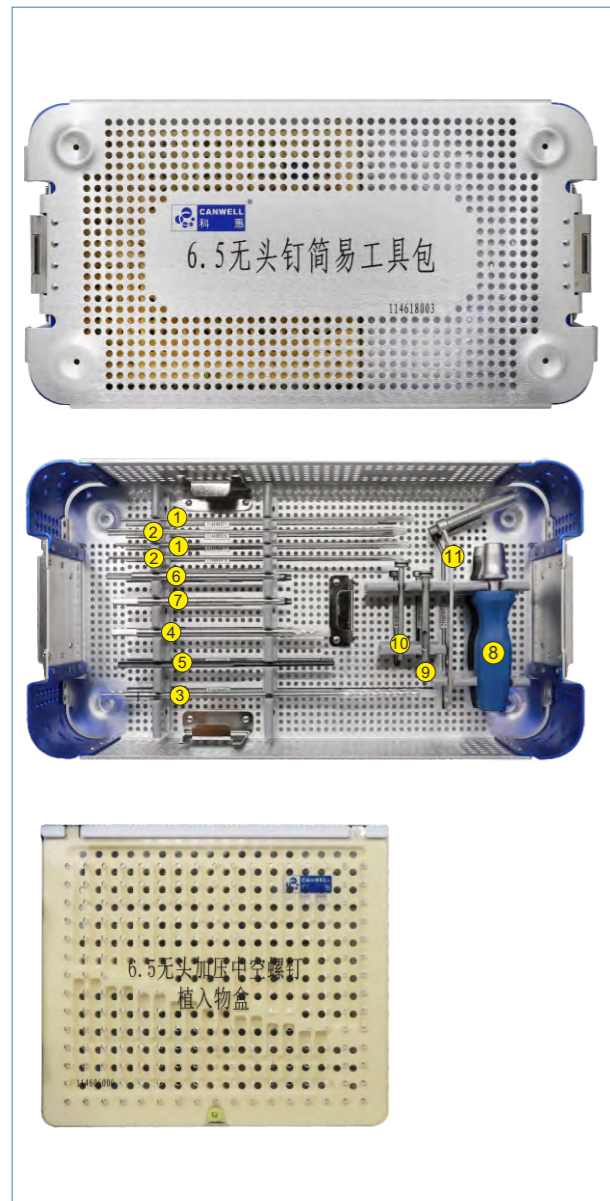

NO.	P.N	Description	Qty.
1	114600075	Φ2.5mm,Guide Wire	4
2	114600076	Φ2.5mm,Guide Wire With Thread	4
3	114600071	Φ5.0mm,Drill Bit	2
4	114600074	Φ6.5mm,Countersink	1
5	114600079	Depth Gauge	1
6	114600072	Screwdriver,Cannulated,T27	1
7	114600073	Screwdriver,T27	1
8	114600065	Quick Coupling Handle	1
9	114600077	Drill Guide	1
10	114600078	Sleeve	1
11	114600062	Drill Guide	1
12	114621006	Φ6.5mm,Implant Tray	1

Proximal Femoral Nail System CanPFN

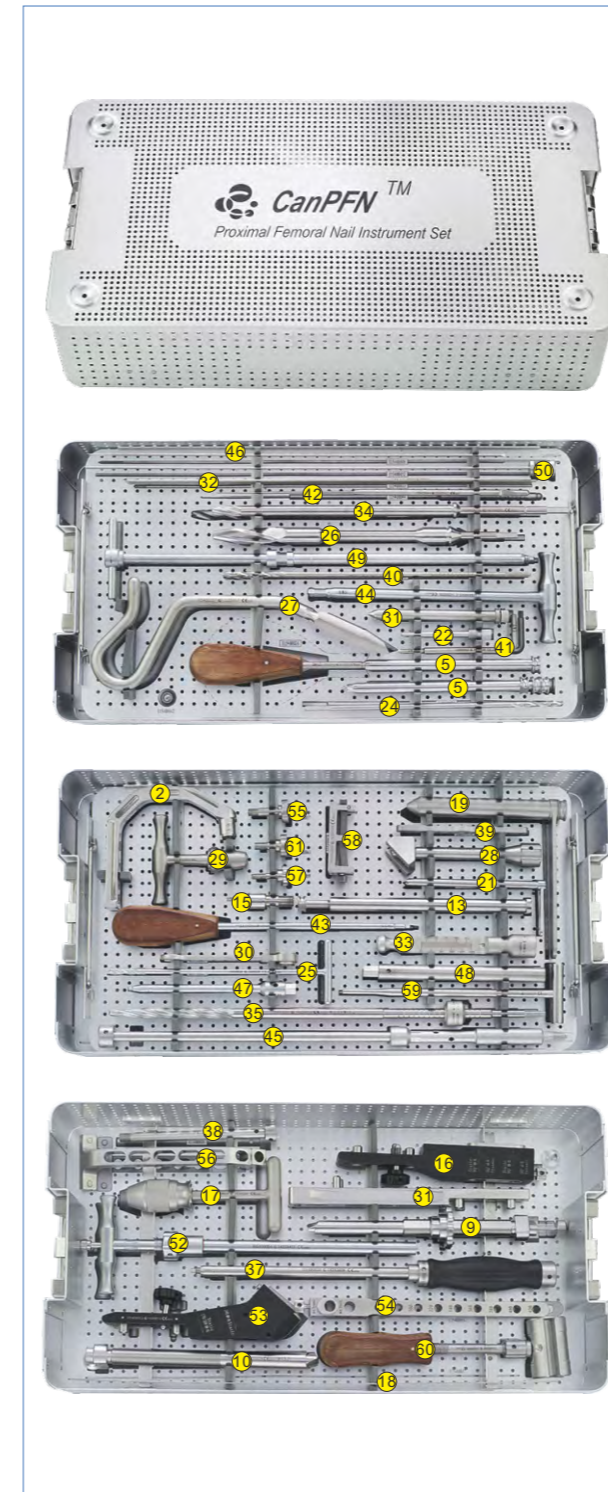

NO.	P.N	Description	Qty.
1	114400011	Hexagonal Solid Screwdriver Length 248mm	1
2	115400001	Insertion Handle	1
3	115400055	Distal Aiming Connecting Shaft	1
4	115400003	Buttress Nut for Proximal Aiming Arm	2
5	115400004	Protection Sleeve for distal locking	2
6	115400005	Obturator for Distal Locking	2
7	115400006	Trocar for Distal Locking	1
8	115400007	Compression Nut	1
9	115400008	Protection Sleeve for blade	1
10	115400009	Protection Sleeve for lag screw	1
11	115400010	Obturator for Blade	1
12	115400011	Obturator for Lag Screw	1
13	115400012	Protection Sleeve for lag screw	1
14	115400013	Trocar	1
15	115400014	Connecting Nut	1
16	115400015	Aiming Arm for distal locking	1
17	115400016	Universal Chunk with T-Handle	1
18	115400017	Radiographic Ruler	1
19	115400018	Protection Sleeve	1
20	115400019	Drill Sleeve	1
21	115400020	Φ5.2Protection Drill Sleeve	1
22	115400021	Temporary End Cap for the lag screw	1
23	115400022	Obturator	1
24	115400023	Φ5.2Drill Bit	1
25	115400024	Flat Drill with T-Handle	1
26	115400025	Proximal Reamer	1
27	115400027	Awl	1
28	115400029	Impactor	1
29	115400030	Quick Connection T-Handle	1
30	115400031	Ratchet Wrench for Nut, hexagonal	1
31	115400062	Location Sleeve	1
32	115400033	Guide Wire Φ3.2×400	5
33	115400034	Depth Gauge for Guide Wire Φ3.2	1
34	115400035	Cannulated Drill Bit for cortex bone Φ10.6/Φ3.2	1
35	115400036	Cannulated Drill Bit with limitΦ10.6/Φ3.2	1
36	115400037	Fixation Sleeve SW4.5/Φ3.2	1
37	115400038	Screwdriver for PFN Blade	1
38	115400039	Extractor Connection shaft for blade	1
39	115400040	Counter-torque Wrench for blade	1
40	115400041	Φ4.3 Drill BitΦ4.3/300mm	3

Proximal Femoral Nail System CanPFN

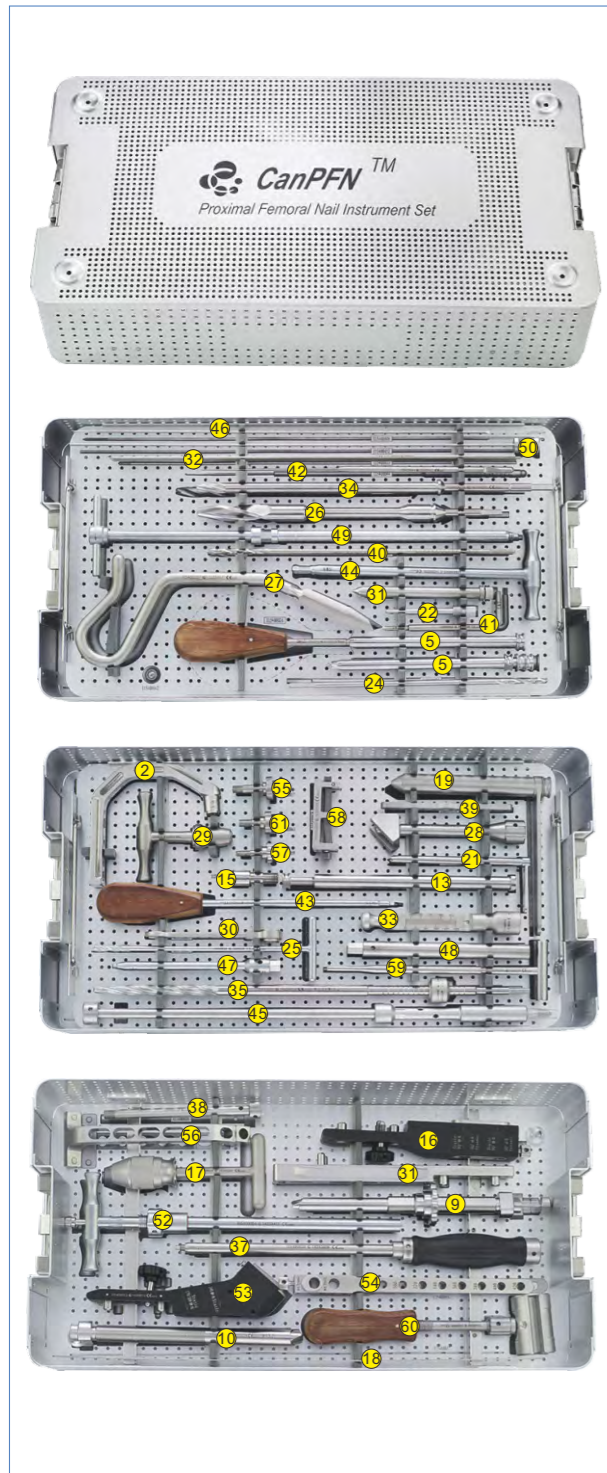

NO.	P.N	Description	Qty.
41	115400043	Pin Wrench SW3/SW5	1
42	115400044	Depth Gauge for Locking screw	1
43	115400045	Screwdriver,hexagonal SW3.5	1
44	115400046	Wrench with T-Handle	1
45	115400047	Extractor for Nail M8	1
46	115400048	Guide Wire with Hook Φ2.8	1
47	115400049	Cannulated Screwdriver for end cap Φ2.8/SW4/SW11	1
48	115400050	Cannulated Wrench for end cap SW11	1
49	115400051	Extractor for Blade SW4.5/Φ3.2	1
50	115400052	Cleaning Wire	1
51	115400053	Lag Screw Holding shaft	1
52	115400054	Wrench shaft for Lag Screw	1
53	115400002	Proximal Aiming Arm	1
54	115400056	Distal Targeting Device for Long Nail	1
55	115400057	Targeting Device Nut for Long Nail	1
56	115400058	Distal Outrigger	1
57	115400059	Distal Outrigger Nut for Long Nail	1
58	115400060	U-shaped Stabilizing Spacer	1
59	115400061	Location Shaft	1
60	115400032	Slotted Hammer	1
61	115400063	Handle Connecting Nut	1
62	115403000	Instrument Tray	1

Proximal Femoral Nail System CanPFN II

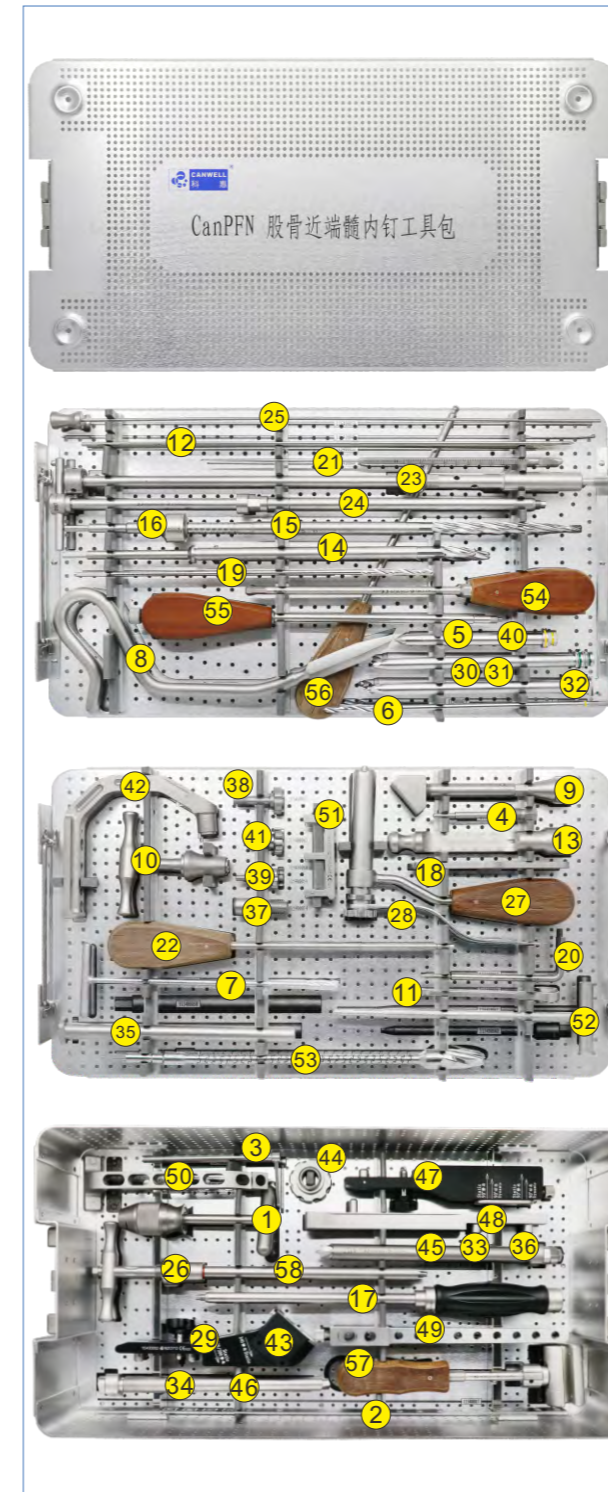

NO.	P.N	Description	Qty.
1	115400016	Universal Chunk with T-Handle	1
2	115400017	Radiographic Ruler	1
3	115400020	Φ5.3/8.2Protection Drill Sleeve	1
4	115400021	Temporary End Cap for the lag screw	1
5	115400022	Obturator	1
6	115400023	Φ5.2Drill Bit	1
7	115400024	Flat Drill with T-Handle	1
8	115400027	Awl	1
9	115400029	Impactor	1
10	115400030	Quick Connection T-Handle	1
11	115400031	Ratchet Wrench for Nut, hexagonal	1
12	115400033	Guide Wire Φ3.2×400	5
13	115400034	Depth Gauge for Guide Wire Φ3.2	1
14	115400035	Cannulated Drill Bit for cortex bone Φ10.6/Φ3.2	1
15	115400036	Cannulated Drill Bit	1
16	115400037	Fixation Sleeve SW4.5/Φ3.2	1
17	115400038	Screwdriver for PFN Blade	1
18	115400040	Counter-torque Wrench for blade	1
19	115400041	Φ4.3 Drill BitΦ4.3/300mm	3
20	115400043	Pin Wrench SW3/SW5	1
21	115400044	Depth Gauge for Locking screw	1
22	115400045	Screwdriver,hexagonal SW3.5	1
23	115400047	Extractor for Nail M8	1
24	115400051	Extractor for Blade SW4.5/Φ3.2	1
25	115400052	Cleaning Wire	1
26	115400053	Lag Screw Holding shaft	1
27	115500002	Protection Sleeve	1
28	115500003	Location Sleeve	1
29	115400003	Buttress Nut for Proximal Aiming Arm	2
30	115400004	Protection Sleeve for distal locking	2
31	115400005	Obturator for Distal Locking	2
32	115400006	Trocar for Distal Locking	1
33	115400010	Obturator for Blade	1
34	115400011	Obturator for Lag Screw	1
35	115400012	Protection Sleeve for lag screw	1
36	115400013	Trocar	1
37	115400014	Connecting Nut	1
38	115400057	Targeting Device Nut for Long Nail	1
39	115400059	Distal Outrigger Nut for Long Nail	1
40	115400062	Location Sleeve	1

Proximal Femoral Nail System CanPFN II

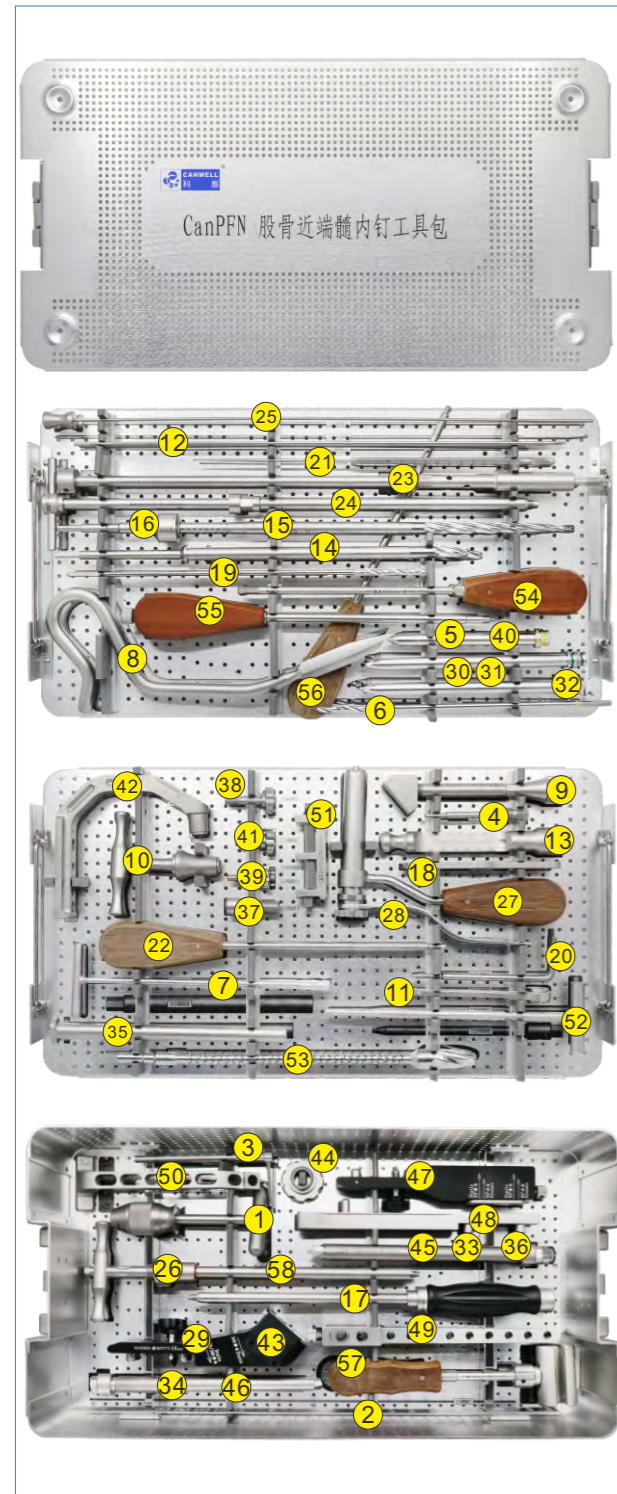

NO.	P.N	Description	Qty.
41	115400063	Handle Connecting Nut	1
42	115420001	Insertion Handle	1
43	115420002	Proximal Aiming Arm	1
44	115420007	Compression Nut	1
45	115410008	Protection Sleeve for blade	1
46	115410009	Protection Sleeve for lag screw	1
47	115410072	Aiming Arm for Distal Locking	1
48	115410055	Distal Aiming Connecting Shaft	1
49	115410056	Distal Targeting Device for Long Nail	1
50	115410058	Distal Outrigger	1
51	115410060	U-shaped Stabilizing Spacer	1
52	115410061	Location Shaft	1
53	115410070	Flexible Proximal Reamer	1
54	115410046	Screwdriver for Connecting Nut	1
55	115410075	SW6 Screwdriver for End Cap with Inner Shaft	1
56	115410076	SW6 Variable Angle Screwdriver for End Cap	1
57	115410032	Slotted Hammer	1
58	115410054	Wrench shaft for Lag Screw	1
59	115413000	Instrument Tray	1

Proximal Femoral Nail System CanPFN(For Lag Screw)

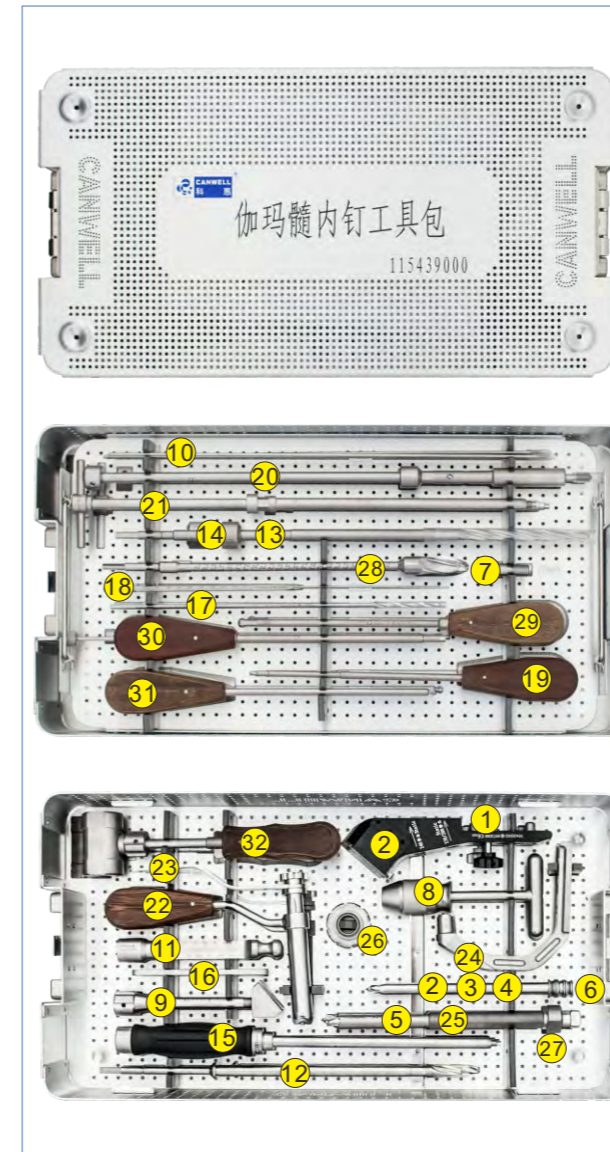

NO.	P.N	Description	Qty.
1	115400003	Buttress Nut for Proximal Aiming Arm	1
2	115400004	Protection Sleeve for distal locking	1
3	115400005	Obturator for Distal Locking	1
4	115400006	Trocar for Distal Locking	1
5	115400010	Obturator for Blade	1
6	115400013	Trocar	1
7	115400014	Connecting Nut	1
8	115400016	Universal Chunk with T-Handle	1
9	115400029	Impactor	1
10	115400033	Guide Wire $\Phi 3.2 \times 400$	5
11	115400034	Depth Gauge for Guide Wire $\Phi 3.2$	1
12	115400035	Cannulated Drill Bit for cortex bone $\Phi 10.6 / \Phi 3.2$	1
13	115400036	Cannulated Drill Bit	1
14	115400037	Fixation Sleeve SW4.5/ $\Phi 3.2$	1
15	115400038	Screwdriver for PFN Blade	1
16	115400040	Counter-torque Wrench for blade	1
17	115400041	$\Phi 4.3$ Drill Bit $\Phi 4.3 / 300\text{mm}$	2
18	115400044	Depth Gauge for Locking screw	1
19	115400045	Screwdriver, hexagonal SW3.5	1
20	115400047	Extractor for Nail M8	1
21	115400051	Extractor for Blade SW4.5/ $\Phi 3.2$	1
22	115500002	Protection Sleeve	1
23	115500003	Location Sleeve	1
24	115420001	Insertion Handle	1
25	115420002	Proximal Aiming Arm	1
26	115420007	Compression Nut	1
27	115410008	Protection Sleeve for blade	1
28	115410070	Flexible Proximal Reamer	1
29	115410046	Screwdriver for Connecting Nut	1
30	115410075	SW6 Screwdriver for End Cap with Inner Shaft	1
31	115410076	SW6 Variable Angle Screwdriver for End Cap	1
32	115410032	Slotted Hammer	1
33	115433000	Instrument Tray	1

Proximal Femoral Nail System CanEFN

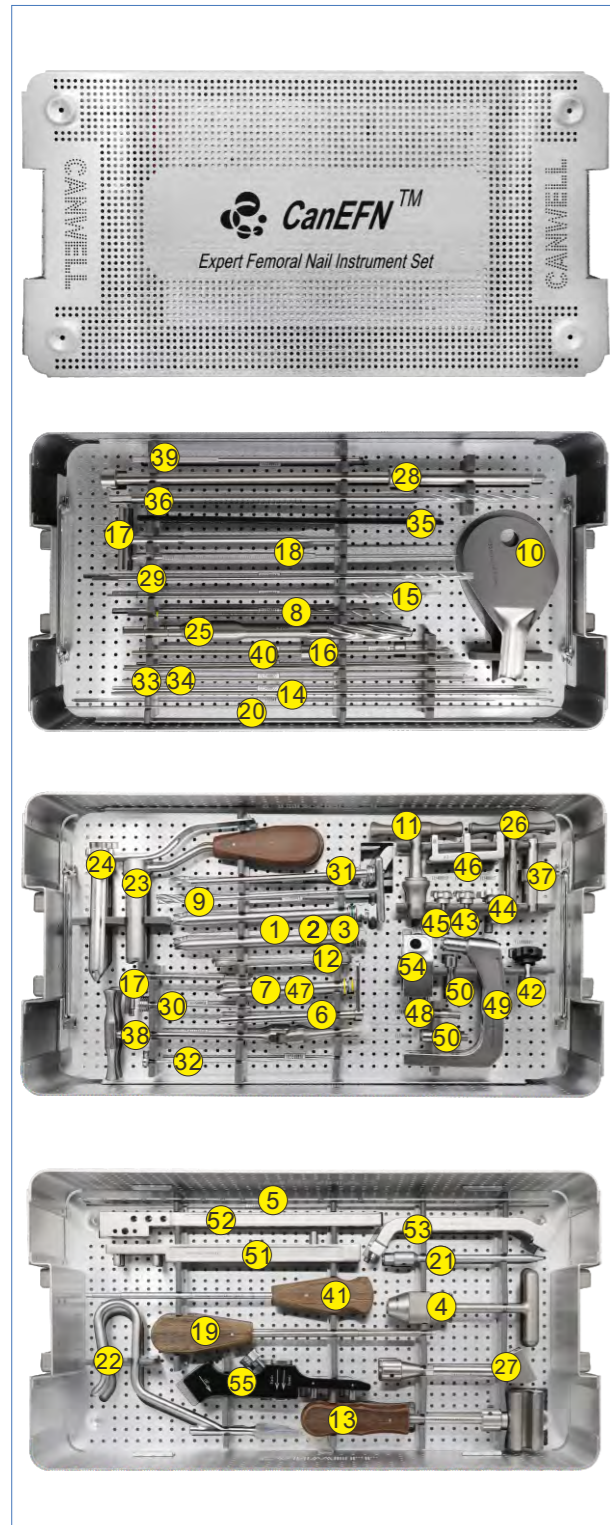

NO.	P.N	Description	Qty.
1	115400003	Buttress Nut for Proximal Aiming Arm	1
2	115400004	Protection Sleeve for distal locking	2
3	115400005	Obturator for Distal Locking	2
4	115400006	Trocar for Distal Locking	1
5	115400016	Universal Chunk with T-Handle	1
6	115400017	Radiographic Ruler	1
7	115400020	Φ5.3/8.2 Protection Drill Sleeve	1
8	115400022	Obturator	1
9	115400023	Φ5.2Drill Bit	1
10	115400024	Flat Drill with T-Handle	1
11	115400026	Tissue Protector	1
12	115400030	Quick Connection T-Handle	1
13	115400031	Ratchet Wrench for Nut, hexagonal	1
14	115400032	Slotted Hammer	1
15	115400033	Guide Wire Φ3.2×400	2
16	115400041	Φ4.3 Drill BitΦ4.3/300mm	2
17	115400042	Φ4.5 Drill Stop Φ4.3/SW3	1
18	115400043	Pin Wrench SW3/SW5	1
19	115400044	Depth Gauge for Locking screw	1
20	115400045	Screwdriver,hexagonal SW3.5	1
21	115400048	Guide Wire with Hook Φ2.8	1
22	115400049	Cannulated Screwdriver for end cap Φ2.8/SW4/SW11	1
23	115400057	Targeting Device Nut for Long Nail	1
24	115400059	Distal Outrigger Nut for Long Nail	2
25	115400062	Location Sleeve	1
26	115500034	Φ4.2 Guide Wire	1
27	115500001	Cannulated Awl	1
28	115500002	Protection Sleeve	1
29	115500003	Location Sleeve	1
30	115500004	Proximal Cannulated Drill bit	1
31	115500005	Handle	1
32	115500006	Connecting Nut	2
33	115500007	Wrench for Connecting Nut	1
34	115500008	Impactor for Nail	1
35	115500009	Extract shaft for Nail	1
36	115500010	Proximal location shaft	1
37	115500012	Distal location shaft	1
38	115500014	Distal Outrigger	1
39	115500015	Distal location block	1
40	115500017	Location shaft	1

Proximal Femoral Nail System CanEFN

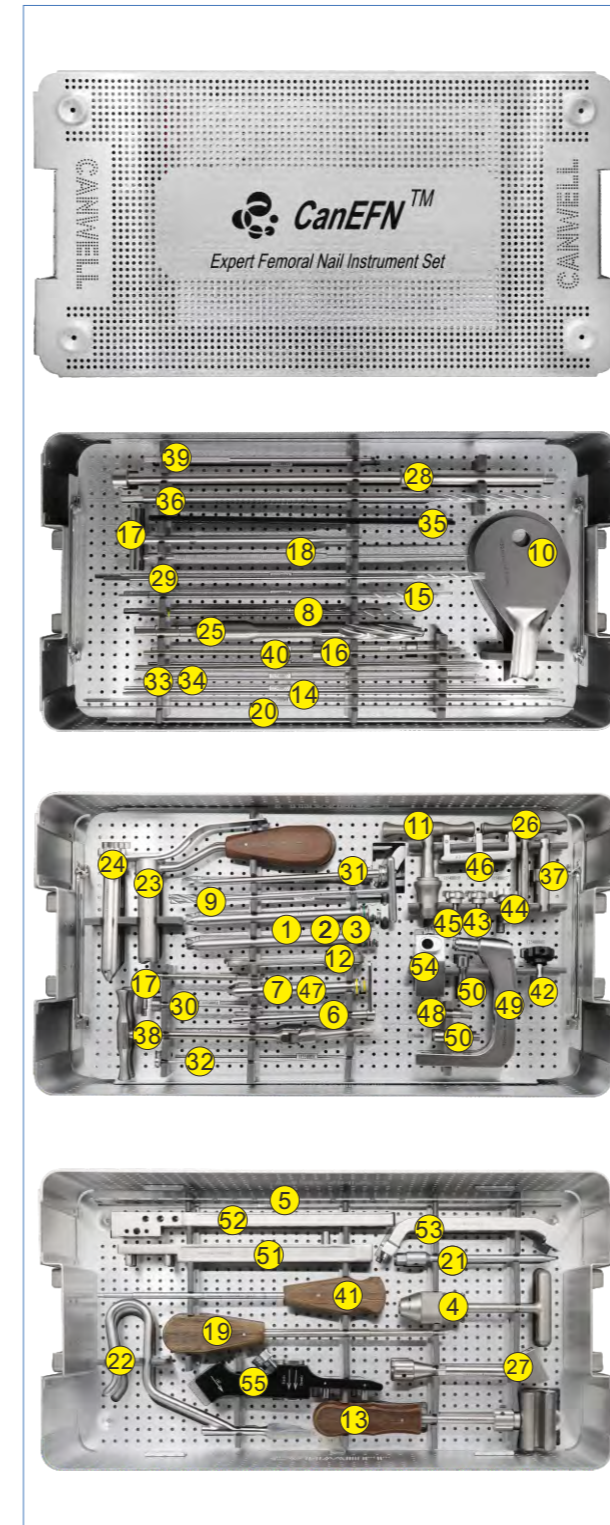

NO.	P.N	Description	Qty.
41	115400060	U-shaped Stabilizing Spacer	1
42	115500019	Drill Bit	2
43	115500022	Aiming Arm	1
44	115500024	Compression Nut	1
45	115500025	Guide wire Sleeve	2
46	115500026	Trocar	1
47	115500027	Guide Wire	2
48	115500028	Guide Wire Φ2.5mm, with threaded tip	4
49	115500029	Depth Gauge for Guide Wire	1
50	115500030	Cannulated drill bit	1
51	115500031	Drill stop	1
52	115500032	Universal Wrench with T-Handle	1
53	115500033	SW4.0 Screw shaft for end cap	1
54	115500063	Handle Connecting Nut	1
55	115500035	Hexagonal Solid Screwdriver	1
56	115503000	Instrument Tray	1

Tibia Nail System CanETN

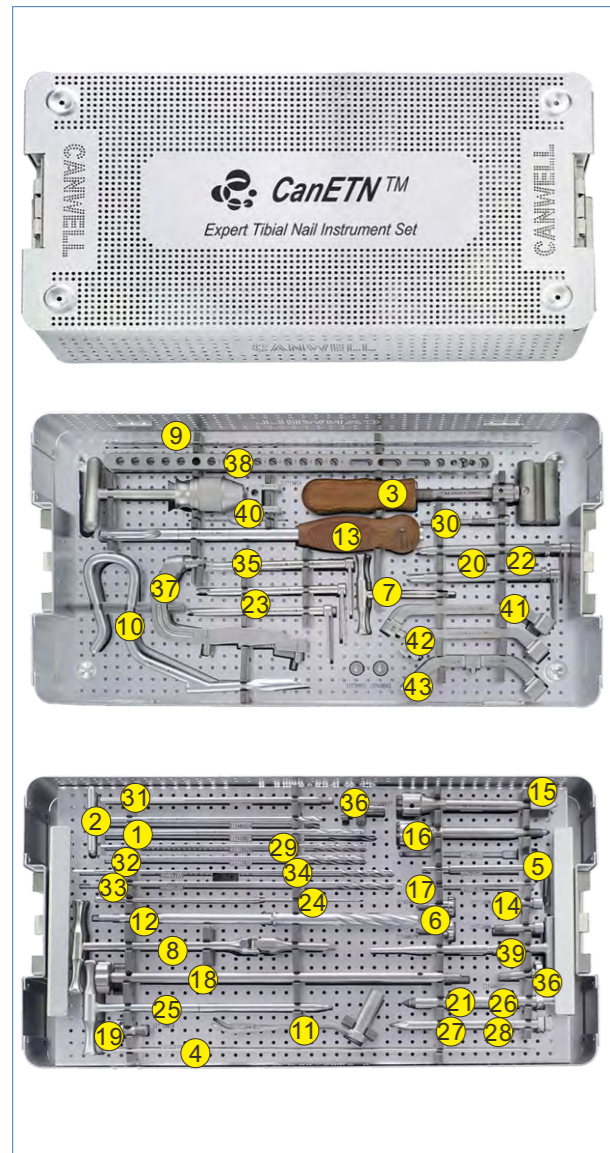

Optional Items

NO.	P.N	Description	Qty.
1	115400016	Universal Chunk with T-Handle	1
2	115400031	Ratchet Wrench for Nut, hexagonal	1
3	115400042	Φ4.5 Drill Stop Φ4.3/SW3	1
4	115700011	Drill stop	1
5	115710006	Tissue Protector	1

NO.	P.N	Description	Qty.
1	115400023	Φ5.2Drill Bit	1
2	115400024	Flat Drill with T-Handle	1
3	115400032	Slotted Hammer	1
4	115400033	Guide Wire Φ3.2×400	3
5	115400043	Pin Wrench SW3/SW5	1
6	115400059	Distal Outrigger Nut for Long Nail	2
7	115500007	Wrench for Connecting Nut	1
8	115500032	Universal Wrench with T-Handle	1
9	115710001	Radiographic Ruler	1
10	115710002	Cannulated Awl	1
11	115710003	Protection Sleeve	1
12	115710004	Cannulated Drill Bit	1
13	115710005	Cannulated Hole Punch	1
14	115710008	Connecting Nut	2
15	115710009	Driving Cap with Handle Adaptor	1
16	115710034	Extractor for Nail	1
17	115710010	Pin Wrench	1
18	115710011	Hammer Guide	1
19	115710016	Distal Outrigger Nut	1
20	115710017	Protection Sleeve	2
21	115710018	Obturator	1
22	115710019	Protection Drill Sleeve(Φ4.3)	2
23	115710020	Protection Drill Sleeve(Φ3.2)	2
24	115710021	Depth Gauge	1
25	115710022	T-handle	1
26	115710025	Protection Sleeve	1
27	115710026	Drill Sleeve	1
28	115710027	Trocar	1
29	115710028	Drill Bit (Φ3.2×250)	1
30	115710029	Compression Bolt	1
31	115710030	Plug for End Cap	1
32	115710031	Drill Bit (Φ4.3×250)	1
33	115710032	Drill Bit (Φ4.3×300)	1
34	115710033	Drill Bit (Φ3.2×300)	1
35	115710035	Φ5.2 Drill Sleeve	1
36	115710036	Targeting Device Nut for Long Nail	1
37	115710007	Insertion Handle	1
38	115710012	Shaft	1
39	115710013	Location Shaft	1
40	115710014	Stabilization Spacer	1
41	115710015	Distal Outrigger	1
42	115710023	Proximal Aming Arm	1
43	115710024	Proximal Aming Arm for Cancellous Bone	1
44	115712000	Instruments Tray(CanETN)	1

Tibia Nail System CanTN

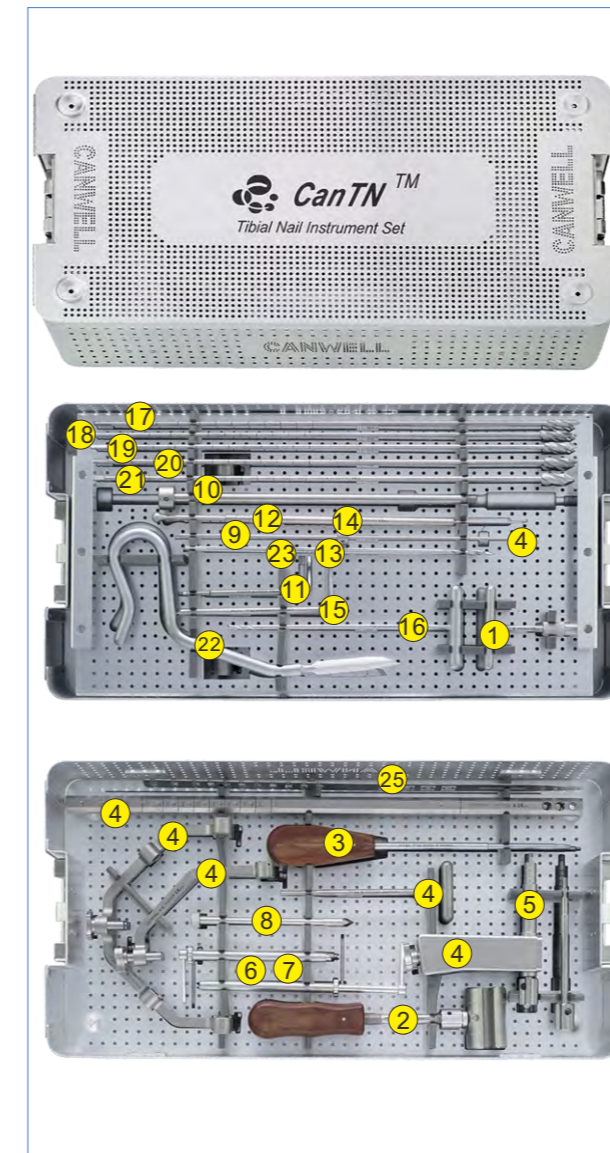

NO.	P.N	Description	Qty.
1	112100024	T-handle with Quick Coupling Length 90mm	1
2	115400032	Slotted Hammer	1
3	115400045	Screwdriver, hexagonal SW3.5	1
4	115700001	Tibia Nail Targeting Device	1
5	115700021	Locking Bolt	1
6	115700002	Protection Sleeve	2
7	115700003	Drill Sleeve	2
8	115700004	Obturator	1
9	115700005	Location Pin	1
10	115700007	Insertor / Extractor for Tibia Nail	1
11	115700008	Wrench	1
12	115700009	Depth Gauge	1
13	115700010	Φ3.2 Drill Bit, Length 28mm	2
14	115700011	Drill stop	1
15	115700012	Φ7/Φ5 Drill Sleeve	1
16	115700013	Flat Drill with T--Handle	1
17	115700014	Φ7 Reamer	1
18	115700015	Φ8 Reamer	1
19	115700016	Φ9 Reamer	1
20	115700017	Φ10 Reamer	1
21	115700018	Φ11 Reamer	1
22	115700019	Three-fluted Awl	1
23	115700020	Φ5 Drill Bit	1
24	115703000	Instrument Tray	1
25	115710001	Radiographic Ruler	1



Dynamic Reaming Instrument Set 115419000

Dynamic Reaming Instrument Set

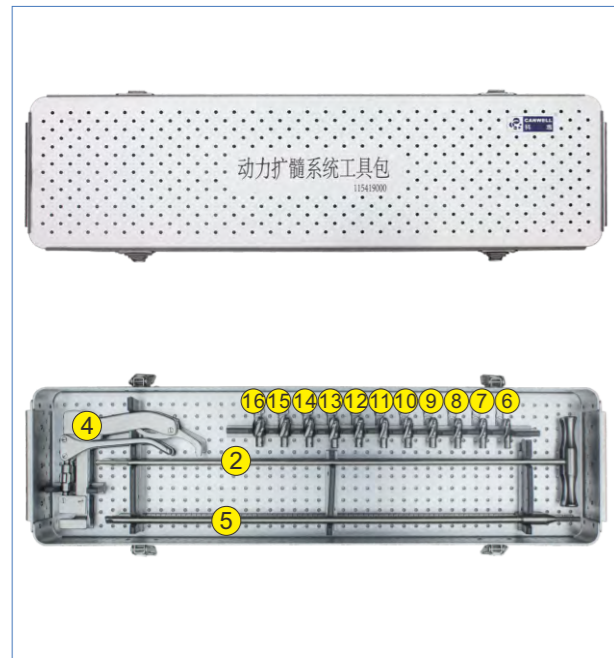

NO.	P.N	Description	Qty.
1	115410007	Ball Head Guider, Φ2.5×680mm	1
2	115410001	Reset Rod with T-Handle	1
3	115410002	Ball Head Guider, Φ2.5×1000mm	2
4	115410003	Extractor for guide Wire	1
5	115410004	Soft Reamer	1
6	115410005	Soft Reamer Head Φ8.5	1
7	115410010	Soft Reamer Head Φ9.0	1
8	115410011	Soft Reamer Head Φ9.5	1
9	115410012	Soft Reamer Head Φ10	1
10	115410013	Soft Reamer Head Φ10.5	1
11	115410014	Soft Reamer Head Φ11	1
12	115410015	Soft Reamer Head Φ11.5	1
13	115410016	Soft Reamer Head Φ12	1
14	115410017	Soft Reamer Head Φ12.5	1
15	115410018	Soft Reamer Head Φ13	1
16	115410019	Soft Reamer Head Φ13.5	1
17		Instrument Tray	1

Foot&Ankle Reconstruction Locking Plate System CanFAR

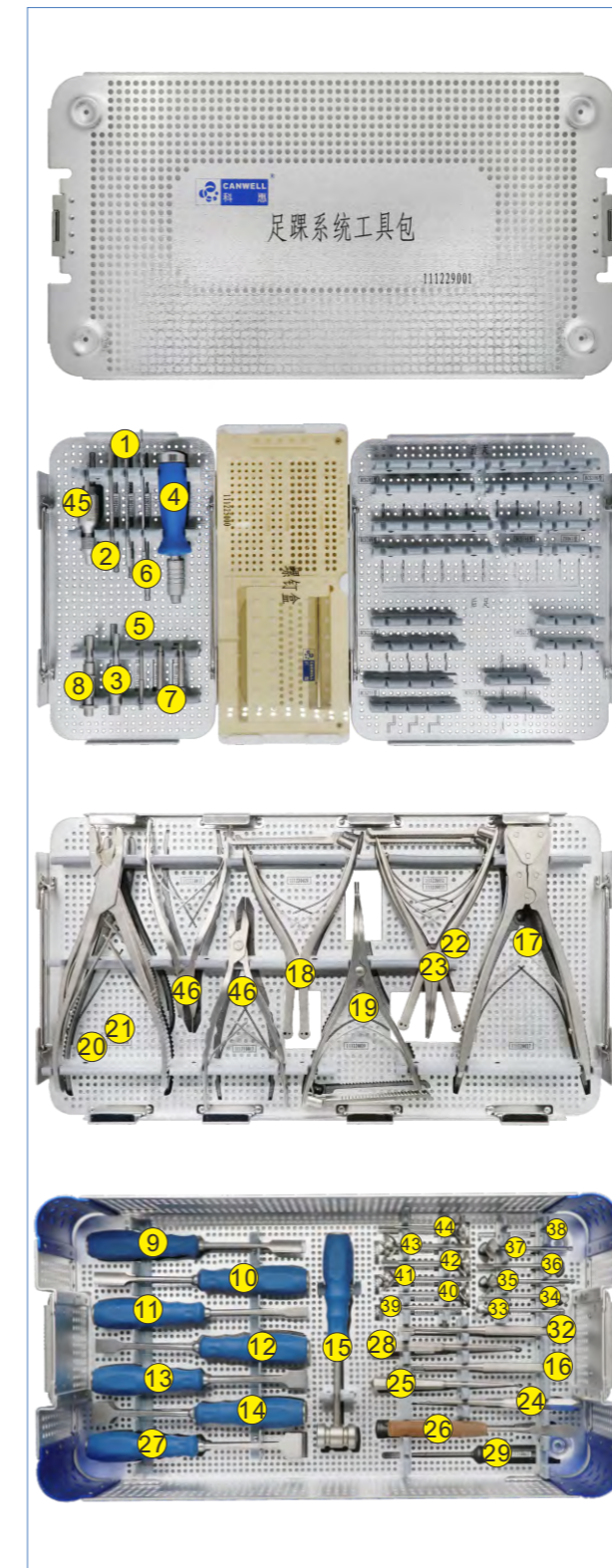

NO.	P.N	Description	Qty.
1	112100018	Tap for Cortex Screw Φ3.5mm Length 112mm Thread Length 30mm	1
2	112230003	T10 screwdriver(long)	1
3	112230004	Quick adapter	1
4	112230005	Straight quick connect handle	1
5	112230006	T10 screwdriver(short)	1
6	112230007	Drill bit,Φ2.5mm	2
7	112230008	Guide drill,Φ2.5mm	2
8	112230009	Screw holder,Φ3.5mm	1
9	111220019	Round bone chisel (reverse edge),13mm	1
10	111220020	Round bone chisel (frount edge),13mm	1
11	111220021	Osteotomy,10mm	1
12	111220022	Osteotomy,14mm	1
13	111220023	Osteotomy,18mm	1
14	111220024	Osteotomy,22mm	1
15	111220025	Bone hammer	1
16	111220026	Round bone chisel,5mm	1
17	111220027	Bone needle scissors	1
18	111220028	Distractor,narrow	1
19	111220029	Distractor,wide	1
20	111220030	3mm Bone rongeur,narrow	1
21	111220031	6mm Bone rongeur,narrow	1
22	111220032	Bone needle distractor	1
23	111220033	Bone needle pressure clamp	1
24	111220034	Curette, 4mm	1
25	111220036	Curette, 6mm	1
26	111220042	Periosteal stripper (large)	1
27	111220043	Osteotomy,26mm	1
28	111220044	Curette, 8mm	1
29	111220045	Periosteal stripper (small)	1
30	111226001	Instrument Tray	1
31	111225001	Screw Tray	1
32	111220002	Osteotomy,6mm	1
33	111220004	14mm Phalange reamer,convex	1
34	111220005	16mm Phalange reamer,convex	1
35	111220006	18mm Phalange reamer,convex	1
36	111220007	20mm Phalange reamer,convex	1
37	111220008	22mm Phalange reamer,convex	1
38	111220009	24mm Phalange reamer,convex	1
39	111220010	14mm Phalange reamer,concave	1
40	111220011	16mm Phalange reamer,concave	1
41	111220012	18mm Phalange reamer,concave	1
42	111220013	20mm Phalange reamer,concave	1
43	111220014	22mm Phalange reamer,concave	1
44	111220015	24mm Phalange reamer,concave	1
45	112110057	1.5Nm torque limit adapter	1
46	111210012	Flat Pliers	2

Variable Angle Minimally Invasive Instrument Set CanVKP

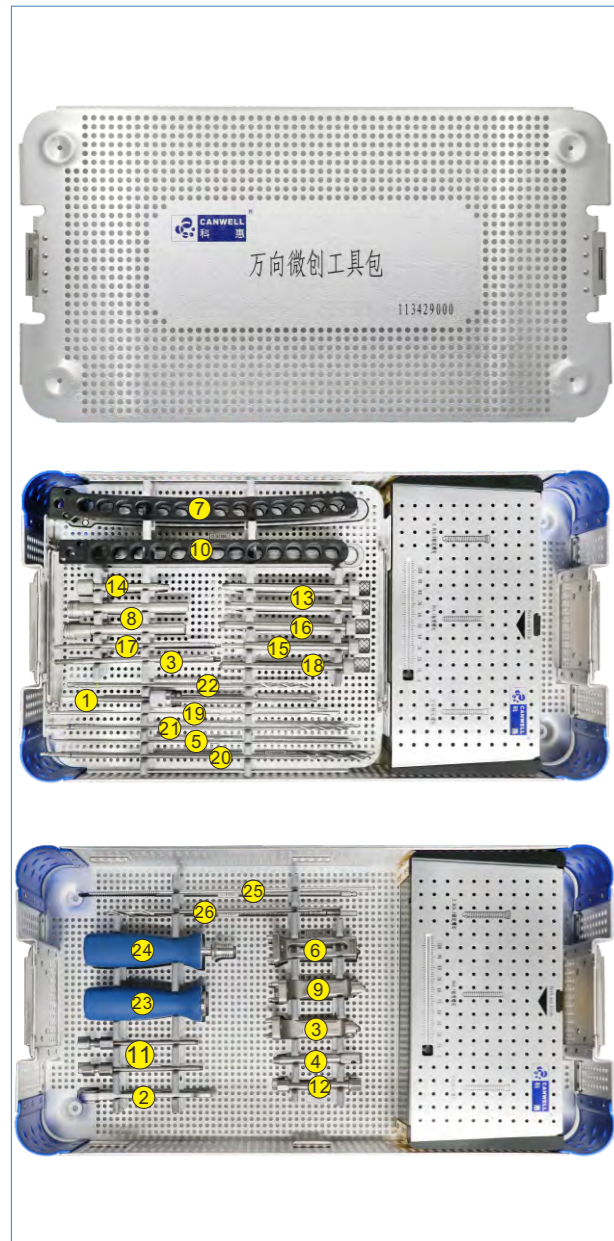

NO.	P.N	Description	Qty.
1	114110015	Screwdriver shaft with quick coupling hexagonal Length 100mm SW3.5	1
2	115400031	Ratchet Wrench for Nut, hexagonal	1
3	113200010	Stardrive screwdriver shaft Length 145mm, T25	2
4	113210004	Φ5.8mm Cannulated drill sleeve	1
5	113420005	Sleeve	1
6	113420006	Handle For Tibia	1
7	113420007	Aiming Arm For Tibia	1
8	113420008	Connecting Nut For Plate	1
9	113420009	Connecting Nut For Aiming Arm	1
10	113400016	K-Wire with Threaded Tip, Φ2mm	4
11	113420003	Insertion Guide for Femur	1
12	113420004	Insertion Guide for Tibia	1
13	113420011	Drill Guide, Φ4.3mm	2
14	113420012	Drill Guide, Φ3.7mm	1
15	113420013	Drill Guide, Φ3.2mm	1
16	113420014	Drill Guide, Φ2.1mm	1
17	113420015	Drill Guide	1
18	113420016	Trocar, Φ8.1mm	1
19	113420017	K wire Measuring Instrument	1
20	113420018	Drill Bit, Φ4.3mm	2
21	113420019	Drill Bit, Φ3.2	1
22	113420020	Drill Bit, Φ3.7	1
23	113420021	Torque limiter, 3.8~4.5Nm	1
24	113420022	Quick Coupling Handle	1
25	113420023	Tap, HA4.5	1
26	113420024	Drill Bit, Φ5.8mm	1
27	113427000	Screw Tray	1
28	113428000	Instrument Tray	1

Pelvic Reconstruction System CanPRS

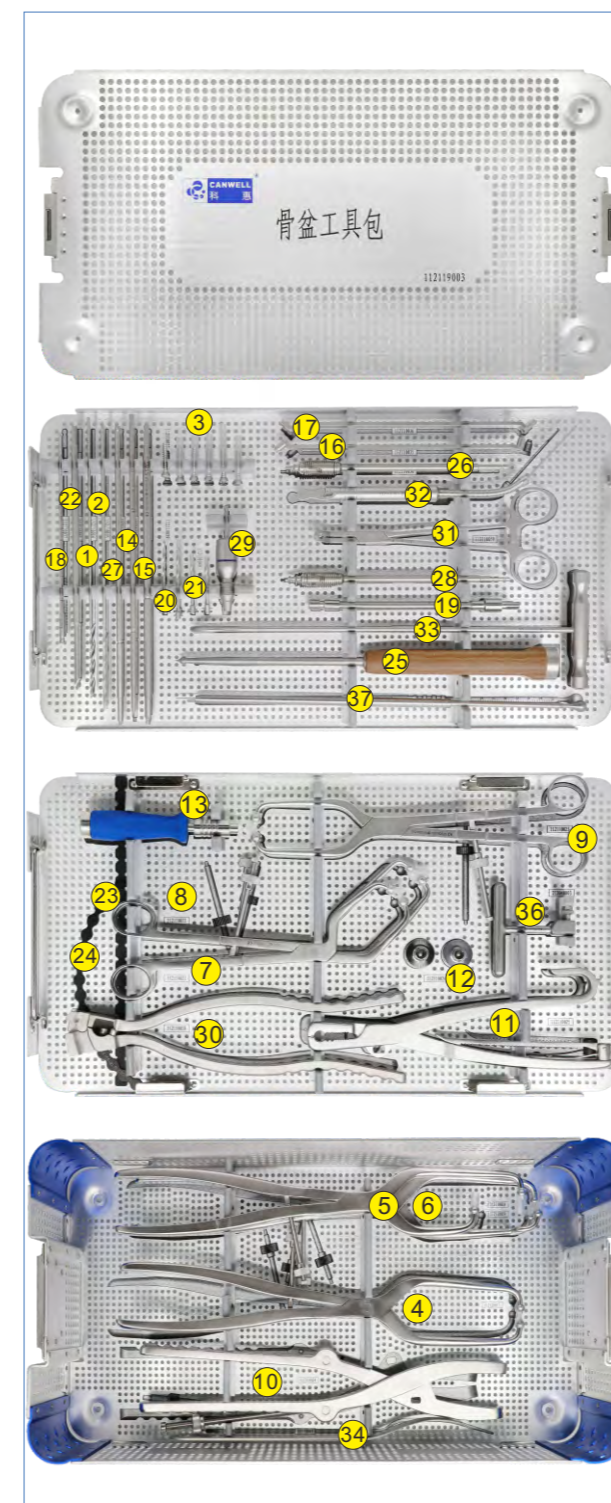

NO.	P.N	Description	Qty.
1	112110004	Drill Bit, Φ3.2mm Length 225mm Thread Length 63mm	1
2	112110005	Drill Bit, Φ2.5mm Length 234mm Thread Length 60mm	2
3	112110027	Reset Clamp Sleeve	6
4	112110017	Reduction Forceps(Large, straight)	1
5	112110018	Reduction Forceps(Large, straight)	1
6	112110019	Reduction Forceps, with 3 Ball Tips	1
7	112110021	Reduction Forceps, Oblique(small)	1
8	112110022	Reduction Forceps, Oblique(large)	1
9	112110023	Reduction Forceps(middle)	1
10	112110024	Pelvis Reset Clamp	1
11	112110025	Farabeuf Forceps(large)	1
12	112110026	Reset Clamp Sleeve	2
13	112230005	Quick Coupling Handle	1
14	112110032	Hexagonal Wrench(SW2.5)	1
15	112110034	Hexagonal Wrench(SW3.5)	1
16	112110035	Drill Guide ( Φ2.5 )	1
17	112110036	Drill Guide ( Φ3.2/Φ3.5	1
18	112110037	Tap (HA3.5)	1
19	112110038	Soft Drill	1
20	112110039	Drill Bit ( Φ2.5 long)	2
21	112110040	Drill Bit ( Φ2.5 short)	2
22	112110041	Lifting rod	1
23	112110042	Curved Reconstruction Plate Trail	1
24	112110043	Straight Reconstruction Plate Trail	1
25	112110047	Crowbar	1
26	112110030	Variable Angle Hexagonal Wrench	1
27	112110051	Stardrive Wrench	1
28	112110052	Variable Angle Stardrive Wrench	1
29	112110057	Quick Coupling Handle Torque limit(1.5N)	1
30	112110058	Bending pliers	1
31	112110059	Holding clamp	1
32	112110060	Depth Gauge(Curved)	1
33	112110061	T-handle hook	1
34	112110062	Periosteal stripper	1
35	112117001	Instrument Tray	1
36	212040003	T-Handle with Quick Coupling	1
37	113400020	Depth Gauge	1

Sternoclavicular Hook System CanSHS

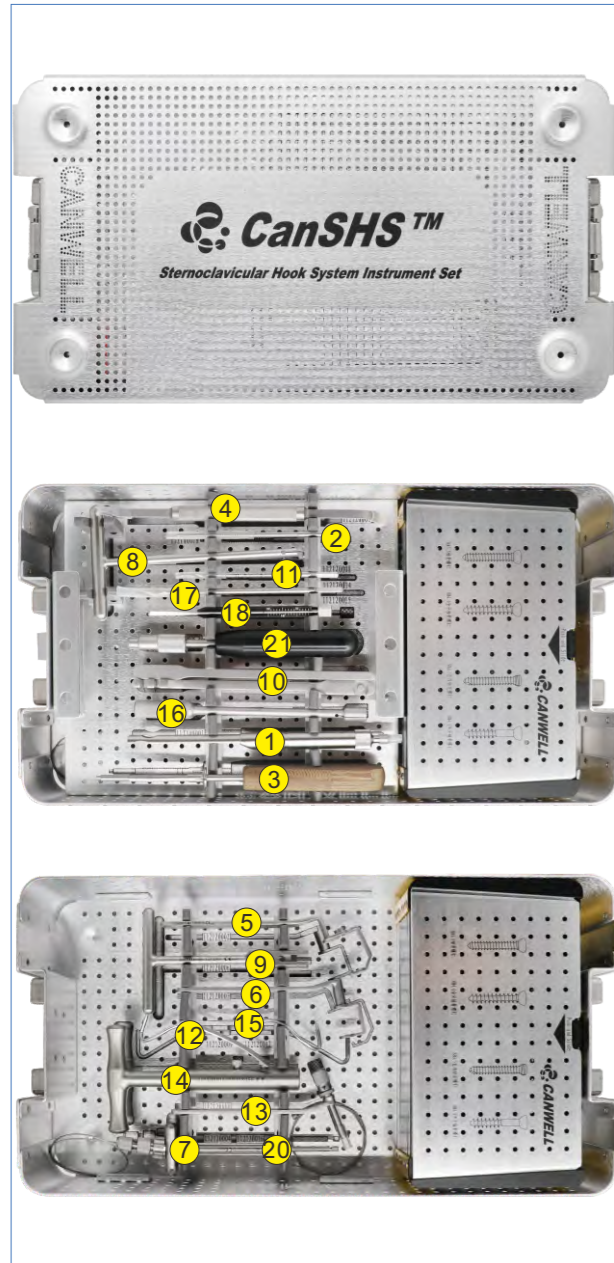

NO.	P.N	Description	Qty.
1	112100001	Depth Gauge for Φ2.5mm-Φ4.0mm Length 60mm	1
2	112100018	Tap for Cortex Screw Φ3.5mm Length 112mm Thread Length 30mm	1
3	112100022	Hexagonal Screwdriver with Holding Sleeve, Length 200mm	1
4	112120001	Periosteal Elevator	1
5	112120002	Drill Guider Height 20mm Inner diameter 4.0mm	1
6	112120003	Cable Guider Height 36mm	1
7	112120004	Guidance Screwdriver	1
8	112120005	Upper Gasket Wrench T-Type Length 150mm	1
9	112120006	Wrench T -Type Length 124mm	1
10	112120007	Plate Bender Length 170mm	2
11	112120008	Φ2.5 Drill Bit Length 112mm	1
12	112120009	Template with screw head, right	1
13	112120010	Drilling deep limiter	1
14	112120011	Radial reverse wrench Length 145mm	1
15	112120012	Template with screw head, left	1
16	112120013	Crosslink Nut Driver Length 150mm	1
17	112120014	Drill Bit, Φ4.2mm Length 145mm Thread Length 48mm	1
18	112120015	Sternum depth Gauge Length 30mm	1
19	112120016	Instruments Tray	1
20	112123000	Guide wire	2
21	211010015	T-Handle with Quick Coupling	1
22	112204000	Screw Tray	1

Screw Extraction Instrument Set CanSES

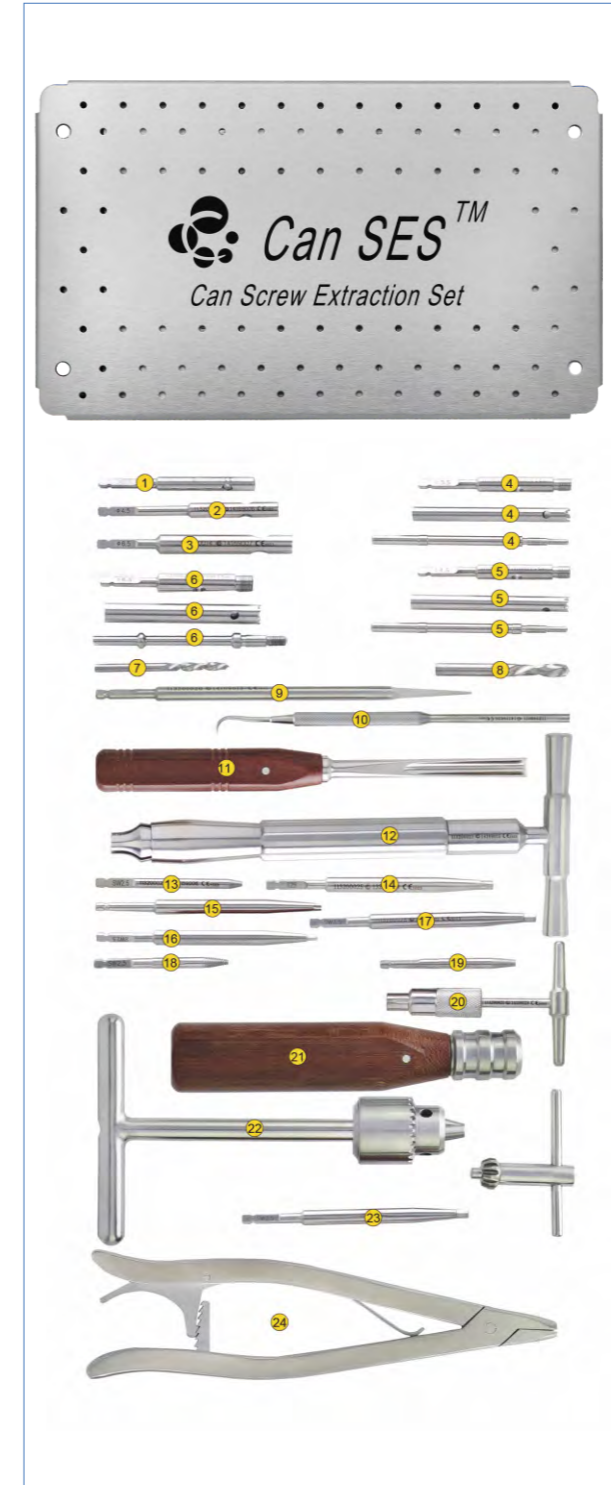

NO.	P.N	Description	Qty.
1	113200012	Screw Extractor(Φ3.5)	1
2	113200013	Screw Extractor(Φ4.5)	1
3	113200014	Screw Extractor(Φ6.5)	1
4	113200015	Reamer Tube(Φ3.5)	1
5	113200016	Reamer Tube(Φ4.5)	1
6	113200017	Reamer Tube(Φ6.5)	1
7	113200018	HSS Drill Bit(Φ4.0)	1
8	113200019	HSS Drill Bit(Φ6.0)	1
9	113200020	Awl	1
10	113200021	Sharp Hook	1
11	113200022	Osteotome	1
12	113200023	Broken Screw Extractor	1
13	113200024	Easyout(SW2.5 fine thread)	1
14	113200025	Stardrive Screwdriver shaft(T25)	1
15	113200026	Stardrive Screwdriver shaft(T15)	1
16	113200027	Hexagonal Screwdriver shaft(SW2.5)	1
17	113200028	Hexagonal Screwdriver shaft(SW3.5)	1
18	113200029	Easyout(SW2.5)	1
19	113200030	Easyout(SW3.5)	1
20	113200031	T-handle with Quick Coupling	1
21	113200032	Straight handle with Quick Coupling	1
22	113200033	Universal Chunk with T-handle	1
23	113200034	Hexagonal Screwdriver shaft(SW4.0)	1
24	113200035	Instrument Box	1
25	113206000	Instrument Tray(CanSES)	1
26	212040008	Screw Clamp	1

Less Invasive Stabilization System Instrument Set CanLISS

Less Invasive Stabilization System Instrument Set CanLISS  
113409000

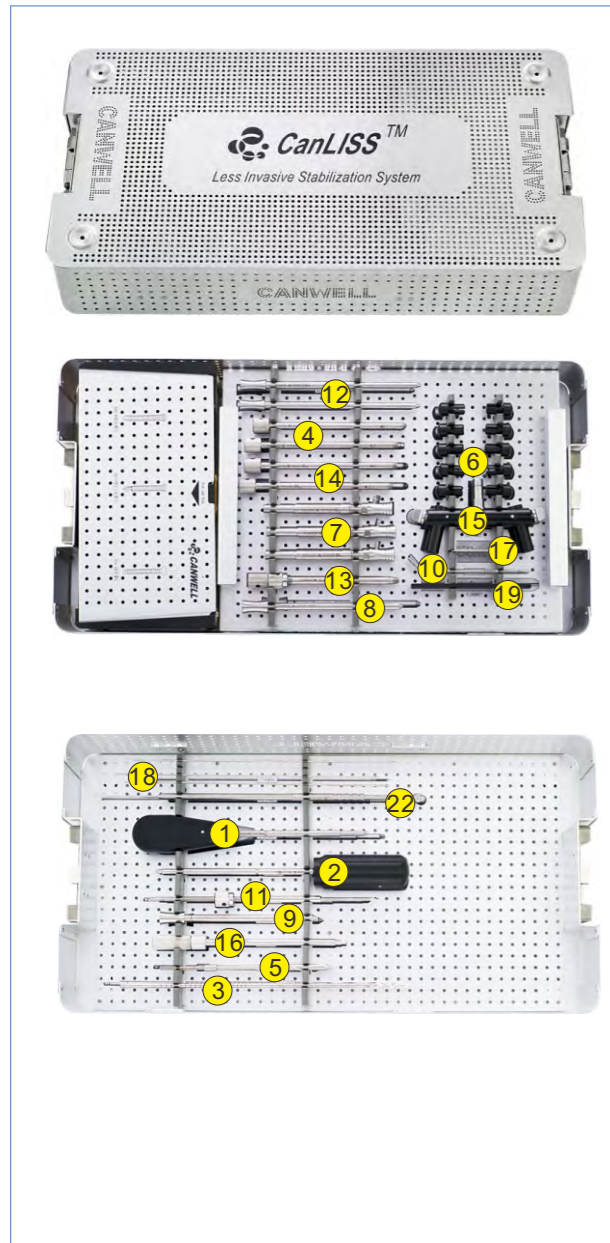

NO.	P.N	Description	Qty.
1	113200009	Screw Driver Length 248mm	1
2	113200038	Torque Limiter 4.5N	1
3	113400001	Drill Bit(Φ4.3)	2
4	113400002	Threaded Drill Sleeve	2
5	113400003	Drill Shaft	1
6	113400004	Hole Stopper	10
7	113400005	Insertion Sleeve	3
8	113400006	Kirschner Wire Insertion Sleeve	1
9	113400007	Trocar	1
10	113400008	Wrench Shaft	1
11	113400009	Pull Reduction Instrument	1
12	113400010	Kirschner Wire Insertion SleeveII	2
13	113400011	Fixation Bolt	1
14	113400012	Stabilization Bolt	2
15	113400013	K-wire Aming Attachment	1
16	113400014	Cleaning Instrument for Screw Head	1
17	113400015	X-Ray Calibrator	2
18	113400016	K-Wire with Threaded Tip	4
19	113400017	K-Wire Measuring Instrument	1
20	113400018	Insertion Guide for Distal Lateral Femur, Right	1
21	113400019	Insertion Guide for Distal Lateral Femur, Left	1
22	113400020	Depth Gauge	1
23	113400022	Insertion Guide for Proximal Tibia, Right	1
24	113400023	Insertion Guide for Proximal Tibia, Left	1
25	113403000	Instrument Tray(CanLISS)	1
26	113404000	Screw Tray(CanLISS)	1

Dynamic Hip and Condylar System CanDHS/CanDCS

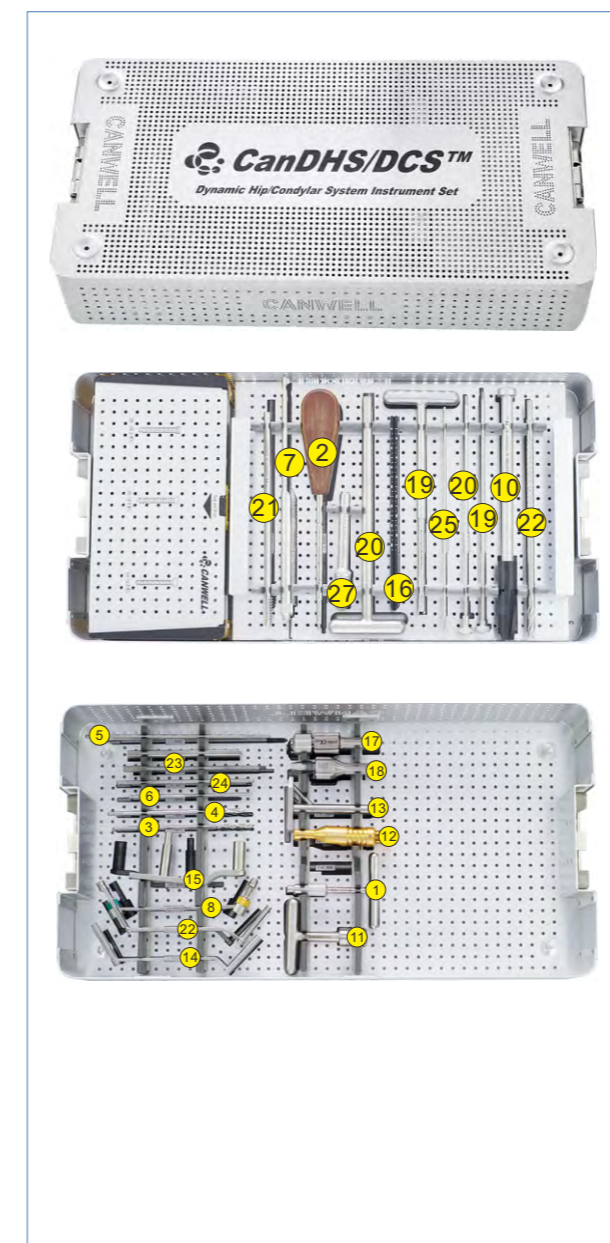

NO.	P.N	Description	Qty.
1	112100024	T-handle with Quick Coupling Length 90mm	1
2	113100001	Hexagonal Screwdriver, Length 248mm	1
3	113100002	Drill Bit, Φ3.2mm Length 147mm Thread Length 40mm	2
4	113100003	Drill Bit, Φ4.5mm Length 145mm Thread Length 48mm	1
5	113100005	Tap for Cancellous Bone Screw Φ6.5mm Length 195mm Thread Length 26mm	1
6	113100006	Tap for Cortex Screw Φ4.5mm Length 130mm Thread Length 70mm	1
7	113100007	Depth Gauge for screws Φ4.5/Φ6.5mm Length 110mm	1
8	113100012	Double Drill Guide Φ3.2mm	1
9	113100013	Universal Drill Guide Φ4.5/3.2mm,	1
10	114110001	CanDHS / DCS Impactor	1
11	114110002	T-Handle with Quick Coupling, for taps and drill guides	1
12	114110003	Centering Sleeve	1
13	114110004	CanDHSTM Angled Guide, 135°	1
14	114110005	Double Drill Guide Φ6.5 / 4.5mm	1
15	114110006	CanDCSTM Angled Guide, 95°	1
16	114110007	Depth Gauge	1
17	114110008	CanDHS Reamer	1
18	114110009	CanDCS Reamer	1
19	114110010	T-Lag Screw Wrench, for insertion	1
20	114110011	T-Lag Screw Wrench, for insertion and removal	1
21	114110012	Tap for CanDHS / DCS Screws	1
22	114110013	Drill Bit, Φ8.0mm	1
23	114110014	Connecting Screw with Guide Shaft	1
24	114110015	Screwdriver shaft with quick coupling, hexagonal Length 100mm SW3.5	1
25	114110016	Guide Wire Φ2.5mm, with threaded tip, length 230mm	4
26	114113000	Instruments Tray	1
27	114400007	Holding Sleeve, Φ8mm Length 120mm	1
28	113204000	Screw Tray	1

Pelvic C-Clamp Instrument Set CanPCC

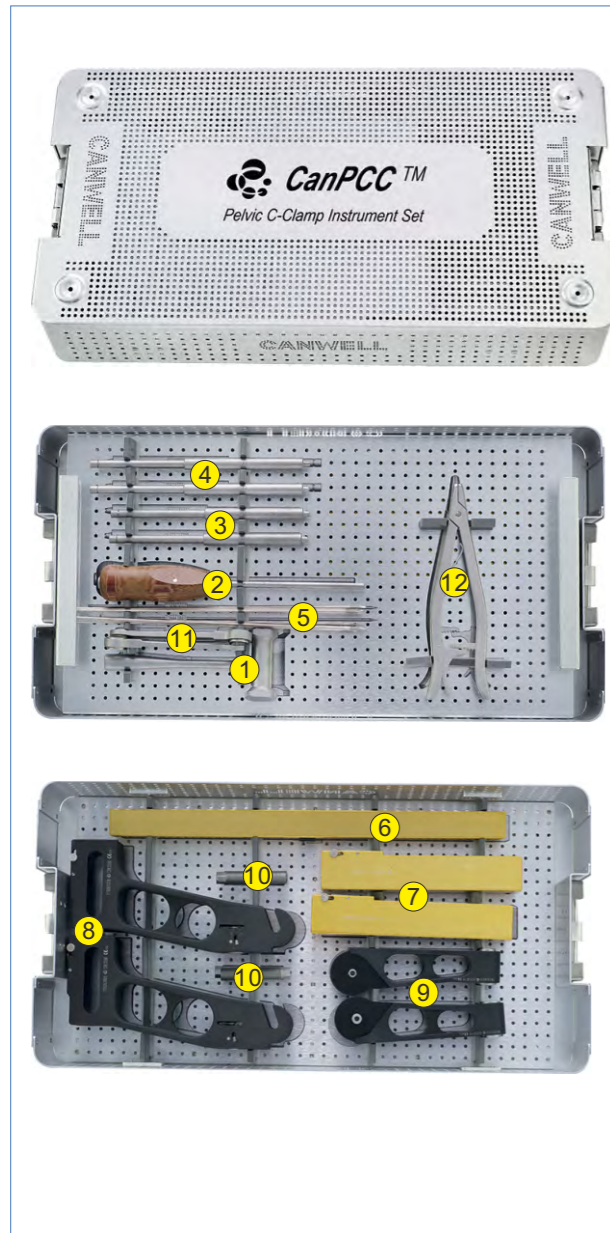

NO.	P.N	Description	Qty.
1	116060001	Socket Wrench with Hammer	1
2	116060002	Guide Handle, for Kirschner Wire	1
3	116060003	Cannulated Nail for Pelvic C-Clamp, short	2
4	116060004	Cannulated Nail for Pelvic C-Clamp, long	2
5	116060005	Kirschner Wire with trocar tip	10
6	116060006	Inner Rail	1
7	116060007	Outer Rail	2
8	116060008	Upper Arm	2
9	116060009	Lower Arm	2
10	116060010	Threaded Tube	2
11	115400031	Ratchet Wrench for Nut, hexagonal	2
12	212040008	Screw Clamp	1
13	116063000	Instrument tray	1

Elastic Nail Instruments set

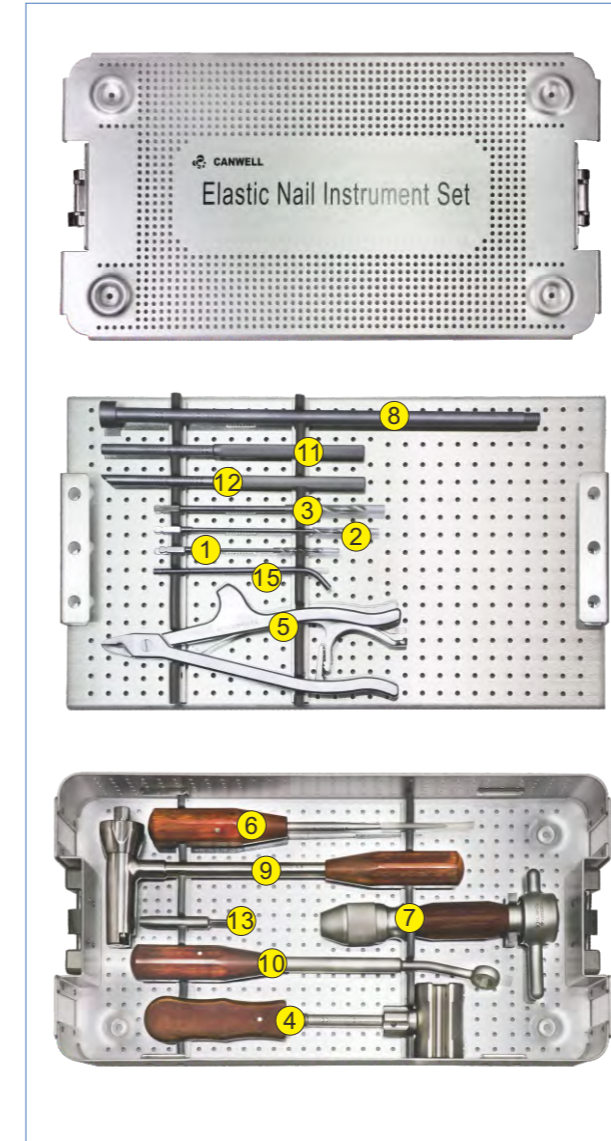

NO.	P.N	Description	Qty.
1	112100016	Drill Bit, $\Phi$ 2.5mm Length 112mm Thread Length 30mm	1
2	113100002	Drill Bit, $\Phi$ 3.2mm Length 147mm Thread Length 40mm	1
3	113100003	Drill Bit, $\Phi$ 4.5mm Length 145mm Thread Length 48mm	1
4	115410032	Slotted Hammer	1
5	115820001	Holder	1
6	115820002	Awl	1
7	115820003	Holder	1
8	115820004	extractor	1
9	115820005	Cutter	1
10	115820006	Wrench	1
11	115820007	Impactor	1
12	115820008	Impactor	1
13	115820009	Screwdriver	1
14	115823000	Instrument tray	1
15	113400008	Wrench	1

Anterior Cervical Plating System CanACP

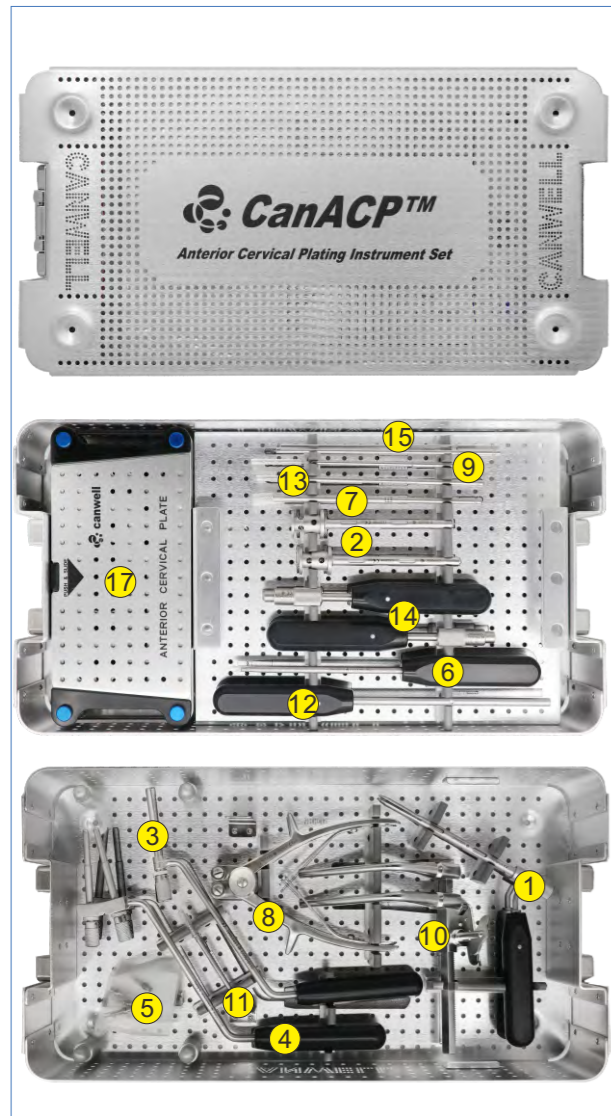

NO.	P.N	Description	Qty.
1	211010001	Plate Holder	1
2	211010002	Screw Holder	2
3	211010003	Drill Guide, single barrel	1
4	211010004	Drill Guide, double barrel	1
5	211010005	Plate Holding Pin	4
6	211010007	Lock Screw Driver Length 230mm	1
7	211010008	Tap for 3.5mm Cortex Screw Thread Length 25mm	1
8	211010009	Plate Bender	1
9	211010010	Drill Bit, $\Phi$ 2.0mm Thread Length 40mm	1
10	211010011	Adjustable Cervical Distractor	1
11	211010012	Distraction Pin Thread Length 14mm	2
12	211010013	Screwdriver for Distraction Pin	1
13	211010014	Awl	1
14	211010015	T-Handle with Quick Coupling	2
15	211010017	Screwdriver, Phillips	2
16	211013000	Instruments Tray	1
17	211014000	Implants Tray	1

Anterior Cervical Plating System CanACCESS

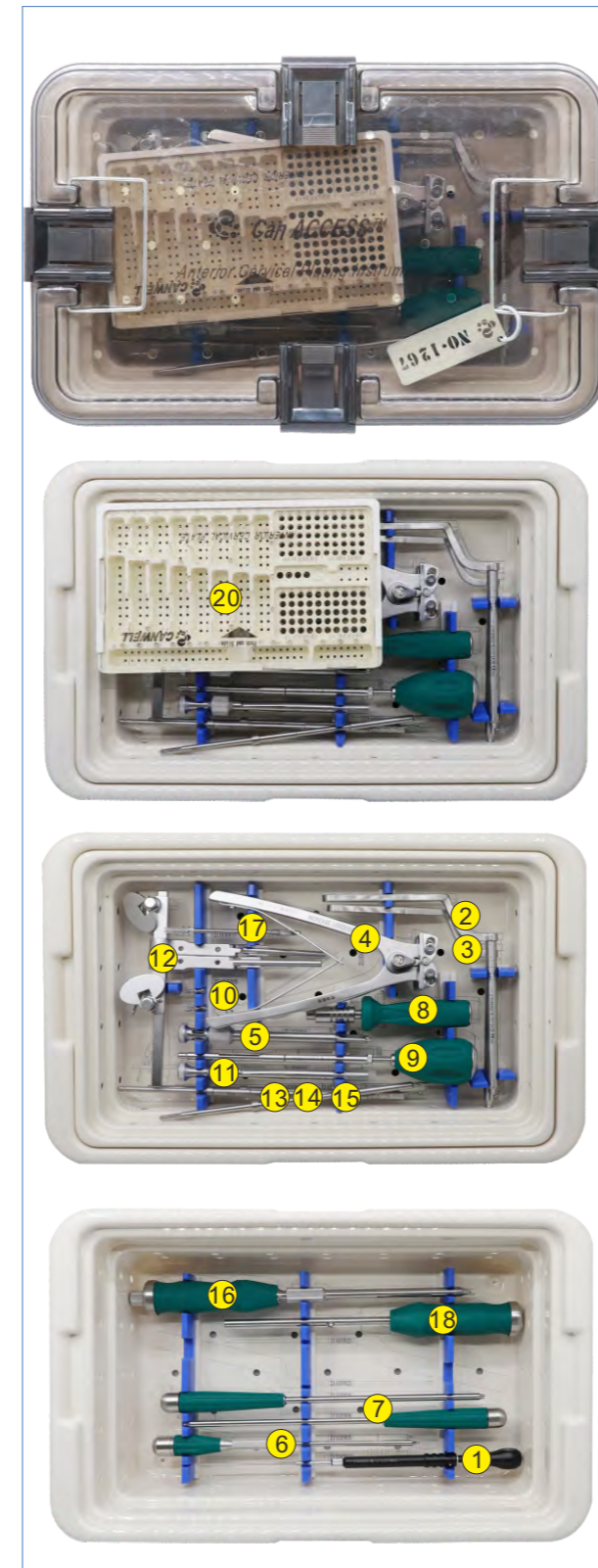

NO.	P.N	Description	Qty.
1	212040012	Depth Gauge	1
2	211030001	Drill Guide, Fixed-Angle	1
3	211030002	Drill Guide, Variable-Angle	1
4	211030003	Cervical Plate Bender	1
5	211030004	Drill, Tap and Screw Guide	1
6	211030005	Screw head Cleaning	1
7	211030006	Screwdriver	2
8	211030007	Quick Coupling Handle	1
9	211030008	Awl(variable angle)	1
10	211030009	Temporary Fixation Pin	4
11	211030010	Holding Sleeve	1
12	211030011	Adjustable Cervical Distractor	1
13	211030012	2.5mm Drill Bit, Head length 14mm	1
14	211030013	2.5mm Drill Bit, Head length 16mm	1
15	211030014	2.5mm Drill Bit, Head length 18mm	1
16	211030015	Extraction Screwdriver	1
17	211030016	Distraction Pin	2
18	211030017	Screwdriver for Distraction Pin	1
19	211031000	Instruments Tray	1
20	211032000	Implants Tray	1

### Anterior Cervical Plating System CanACE

NO.	P.N	Description	Qty.
1	212040012	Depth Gauge	1
2	211030003	Cervical Plate Bender	1
3	211030007	Quick Coupling Handle	1
4	211030031	Cervical Distractor	1
5	211030016	Distraction Pin	2
6	211030017	Screwdriver for Distraction Pin	1
7	211030032	Cervical Distractor	1
8	211040003	Plate Holder	1
9	211040004	Extraction Screwdriver(star)	2
10	211040005	Drill Guide, Fixed angle	1
11	211040006	Drill Guide, Variable angle	1
12	211040007	Temporary Fixation Pin	2
13	211040008	Awl	1
14	211040009	3.00mm Drill Bit, Head length 13mm	1
15	211040010	3.00mm Drill Bit, Head length 15mm	1
16	211040011	3.00mm Drill Bit, Head length 17mm	1
17	211043000	CanACE instrument tray	1
18	211044000	CanACE implant tray	1

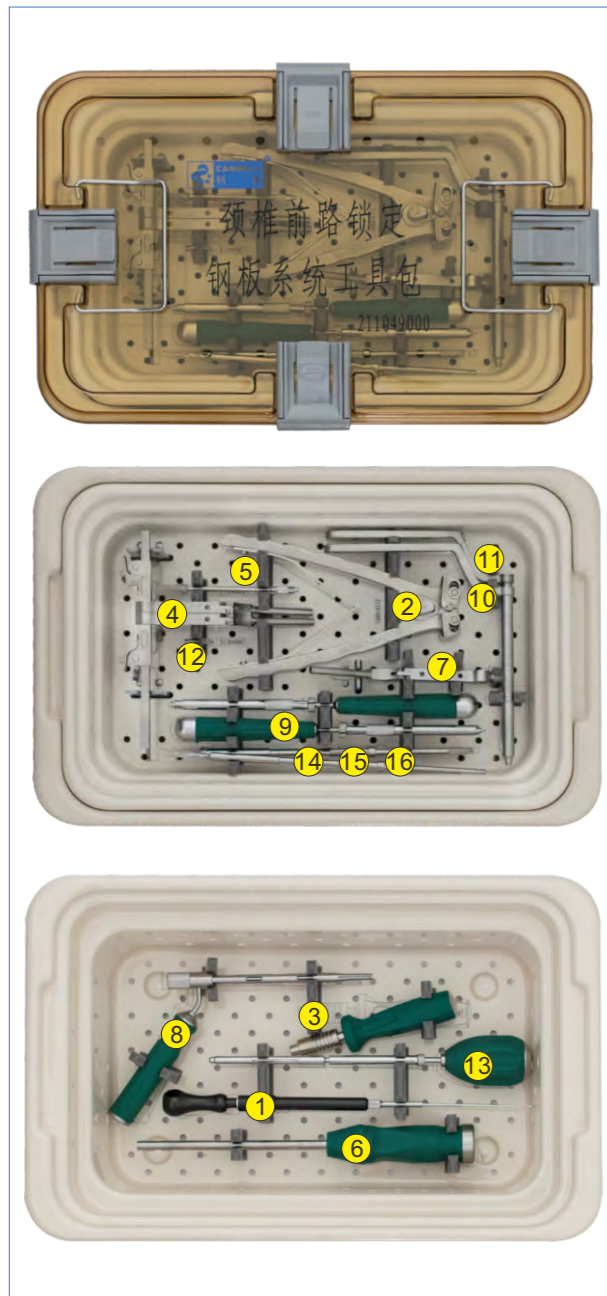

### Posterior Thoracolumbar System CanFIX

NO.	P.N	Description	Qty.
1	212010001	Awl Length 228mm	1
2	212010002	Pedicle Probe, Φ3.0mm, straight Length 232mm	1
3	212010003	Pedicle Probe, Φ3.5mm, straight Length 232mm	1
4	212010004	Screw Tab Breaker	1
5	212010006	Universal Screw Driver Length 258mm	1
6	212010007	Rod Pusher	1
7	212010008	Depth-limited Awl	1
8	212010009	Feeler for Screw Channel, curved Length 225mm	1
9	212010010	Plug Driver, with T-handle	2
10	212010011	Monoaxial Screwdriver	1
11	212010012	Polyaxial Screwdriver	1
12	212010013	Rod Rotation Wrench, hexagonal	1
13	212010014	Rod Holder	1
14	212010015	Rod Bender Length 283mm	1
15	212010016	Compression Forceps Length 338mm	1
16	212010017	Distraction Forceps Length 330mm	1
17	212010018	Power Grip, Length 293mm	1
18	212010019	Compression Sleeve Length 220mm	2
19	212010020	Counter Torque Wrench Length 230mm	1
20	212010021	Marker Inserter(cylindrical) Length 80mm	3
21	212010022	Marker Inserter(sphere) Length 80mm	3
22	212012000	Instruments Tray	1
23	212013000	Implant tray(CanFIX)	1
24	212020004	Plug Starter	2
25	212030022	Feeler for Screw Channel, straight Length 225mm	1

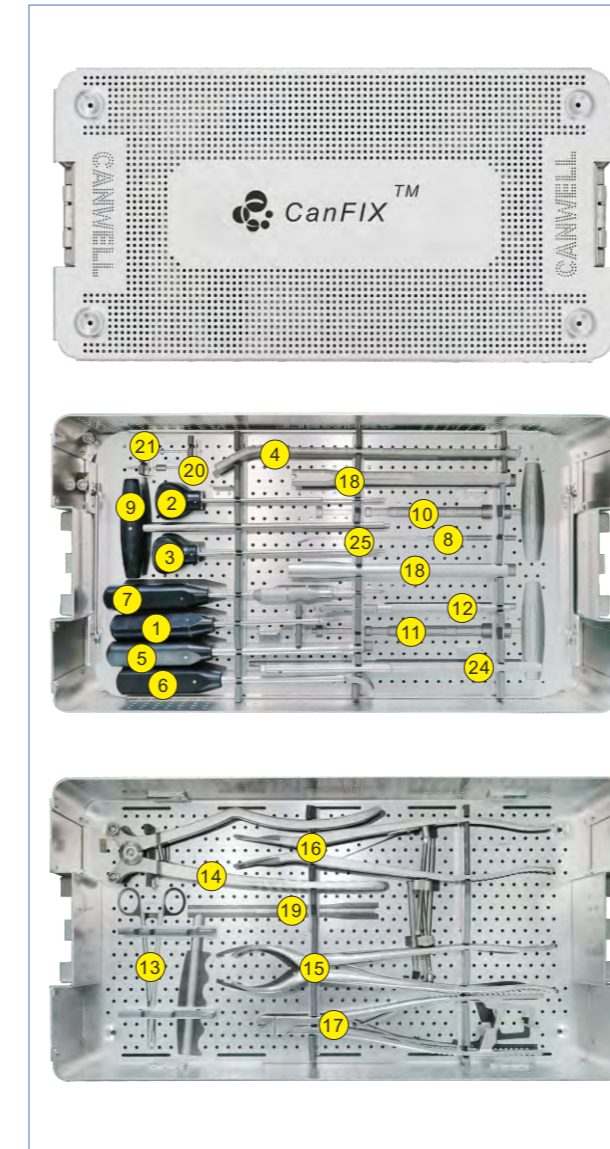

Posterior Thoracolumbar Universal Instruments Set

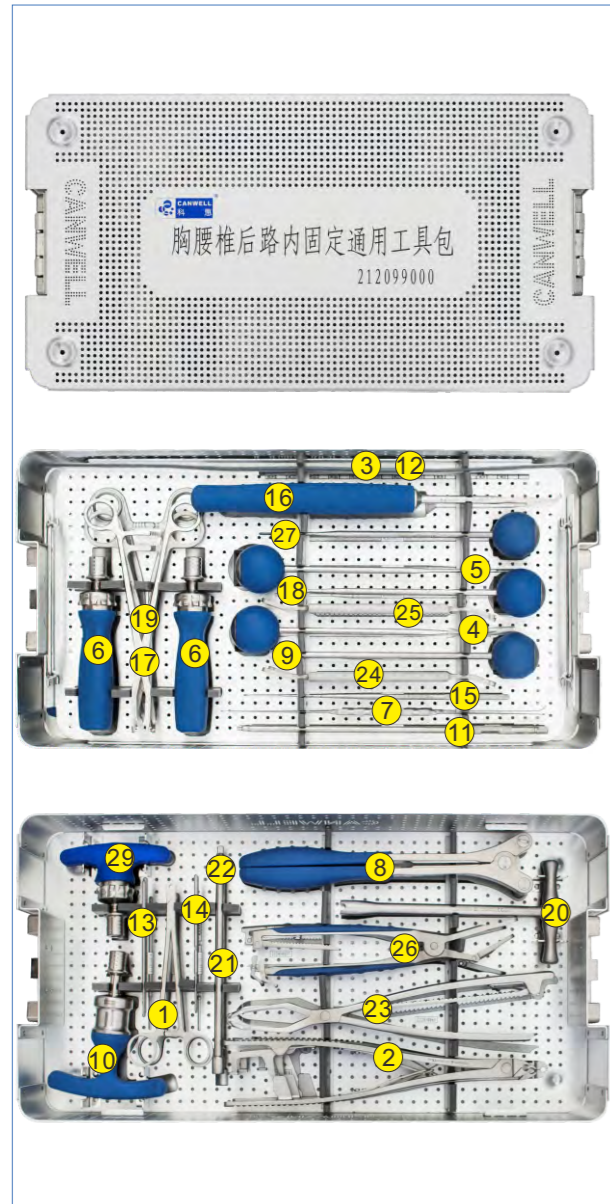

NO.	P.N	Description	Qty.
1	212010014	Rod Holder	1
2	212010018	Power Grip,Length 293mm	2
3	212020029	Rod Template Length 210mm	1
4	212050009	Thoracic Speed Shift	1
5	212050010	Lumbar Speed Shift	1
6	212050013	Quick Coupling Handle	2
7	212050019	Dual Sides Probe	1
8	212050043	Rod Bender	1
9	212050045	Awl with Palm Handle	1
10	212050025	Torque Limiter(12.5N.M)	1
11	212050050	Crosslink Set Driver(SW3.5)	1
12	212050052	Rod Template(500mm)	1
13	212050055	Marker Inserter(Left)	3
14	212050054	Marker Inserter(Right)	3
15	212030022	Feeler for Screw Channel, straight Length 225mm	1
16	212060005	C-shaped Rod Pusher	1
17	212060008	Rod Pusher(6.0mm)	1
18	212050064	Awl with Palm Handle	1
19	212050058	Crosslink Holder	1
20	212050059	Countertorque, for crosslink	1
21	212050060	SW5.5 Crosslink Nut Driver	1
22	212050061	Sw8 Crosslink Nut Driver	1
23	212050063	Parallel Compression Forceps	1
24	212050070	Rod Rotation Wrench 6.0	1
25	212050071	Rod Rotation Wrench 5.5	1
26	212050077	Orthopedic pliers	1
27	212050076	Awl	1
28	212014000	Instruments Tray	1
29	216010012	Quick Connection T-Handle	1

Posterior Thoracolumbar System CanART

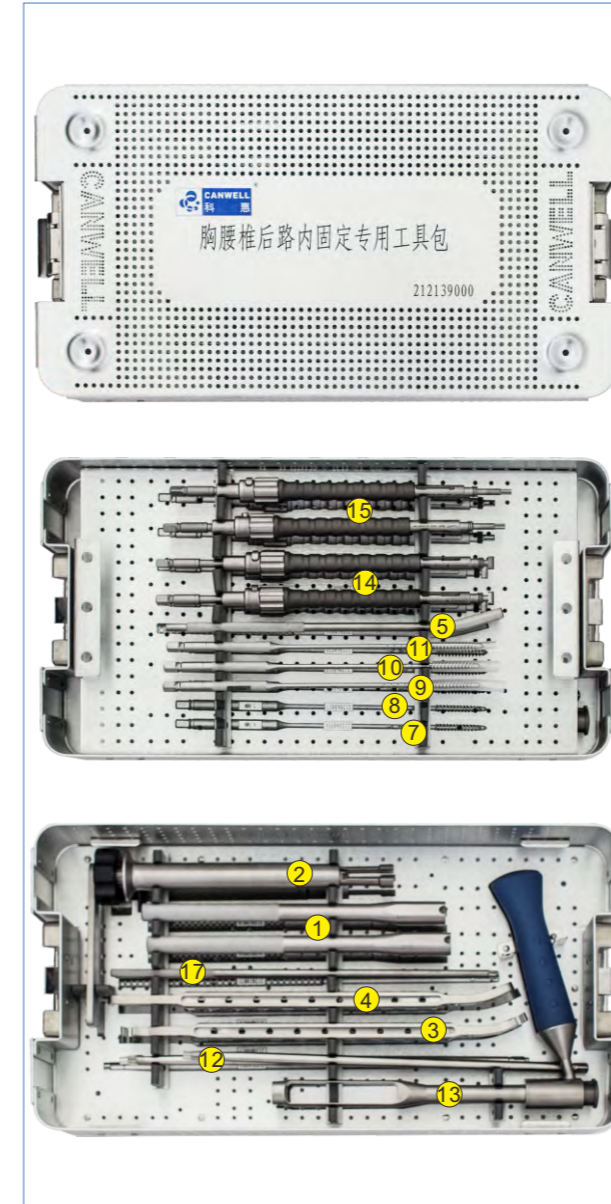

NO.	P.N	Description	Qty.
1	212010019	Compression Sleeve Length 220mm	2
2	212020026	Reduction Forceps	1
3	212060012	In-situ Bender, left	1
4	212060013	In-situ Bender, right	1
5	212060015	Reduction Screw Tab Breaker	1
6	212057900	Universal Spinal Screw Tray	1
7	212060016	Tap(4.5mm)	1
8	212060017	Tap(5.0mm)	1
9	212060018	Tap(5.5mm)	1
10	212060019	Tap(6.0mm)	1
11	212060020	Tap(6.5mm)	1
12	212060023	Plug Driver	2
13	212060037	wrench	1
14	212060035	Monaxial Screwdriver	2
15	212060036	Polyaxial Screwdriver	2
16	212065000	Instruments Tray	1
17	212010035	Plug Starter	2



CanTSP5.5 Instruments Set

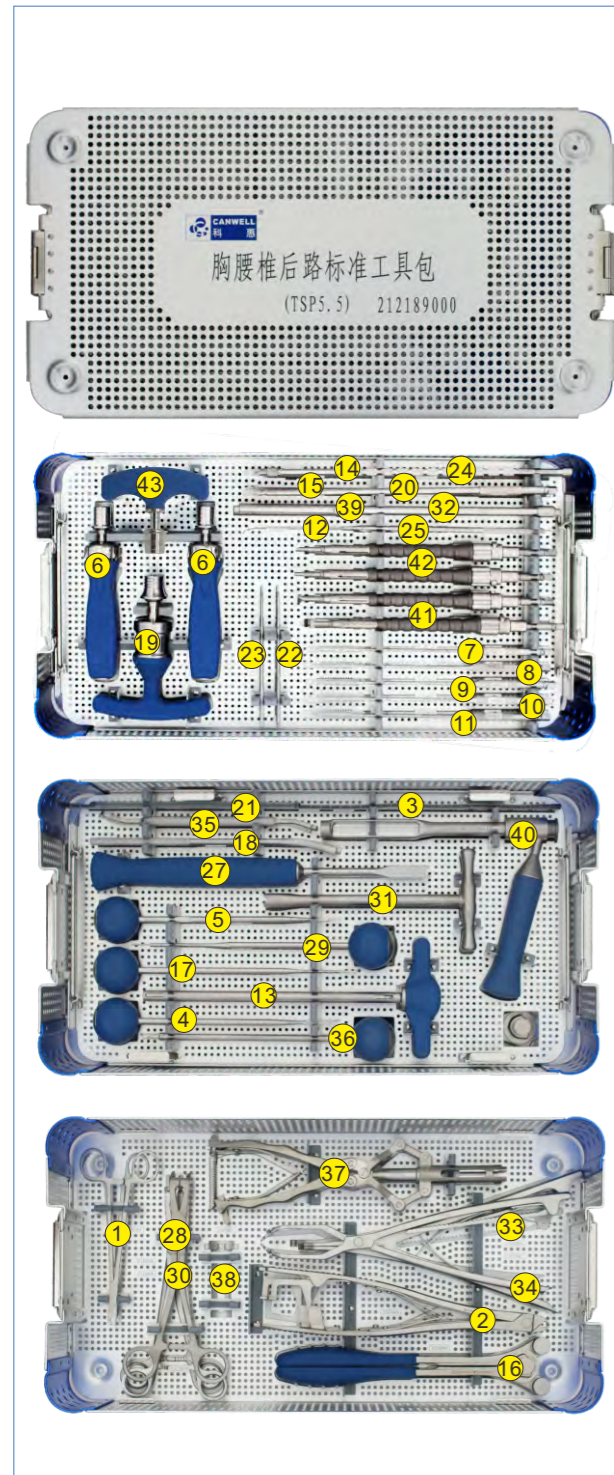

NO.	P.N	Description	Qty.
1	212010014	Rod Holder	1
2	212010018	Power Grip,Length 293mm	2
3	212020029	Rod Template Length 210mm	1
4	212050009	Thoracic Speed Shift	1
5	212050010	Lumbar Speed Shift	1
6	212050013	Quick Coupling Handle	2
7	212050014	Tap(4.5mm)	1
8	212050015	Tap(5.0mm)	1
9	212050016	Tap(5.5mm)	1
10	212050017	Tap(6.0mm)	1
11	212050018	Tap(6.5mm)	1
12	212050019	Dual Sides Probe	1
13	212050037	Self-retaining Break-off Driver	1
14	212050038	Stardrive screwdriver	1
15	212050039	Quick Coupling Plug driver	2
16	212050043	Rod Bender	1
17	212050045	Awl with Palm Handle	1
18	212050048	Reduction Screw Tab Breaker	1
19	212050079	Torque Limiter( 12.5N.M)	1
20	212050050	Crosslink Set Driver(SW3.5)	1
21	212050052	Rod Template(500mm)	1
22	212050055	Marker Inserter(Left)	3
23	212050054	Marker Inserter(Right)	3
24	212050949	Dual End Plug Starter(short)	2
25	212030022	Feeler for Screw Channel, straight Length 225mm	1
26	212182000	Instruments Tray	1
27	212060005	C-shaped Rod Pusher	1
28	212060008	Rod Pusher(6.0mm)	1
29	212050064	Awl with Palm Handle	1
30	212050058	Crosslink Holder	1
31	212050059	Countertorque, for crosslink	1
32	212050060	SW5.5 Crosslink Nut Driver	1
33	212050062	Parallel Distraction Forceps	1
34	212050063	Parallel Compression Forceps	1
35	212050071	Rod Rotation Wrench 5.5	1
36	212050076	AWL	1
37	212050964	Reduction Forceps	1
38	212050065	Extender	1
39	212050069	screwdriver	1
40	212050075	Counter Torque Wrench	1
41	212050072	Screw Driver, Monoaxial, Polaris Pedicle Screw System	2
42	212050073	Polyaxial Screwdriver	2
43	216010012	Quick Connection T-Handle	1

CanTSP5.5 Instruments Set For Correction

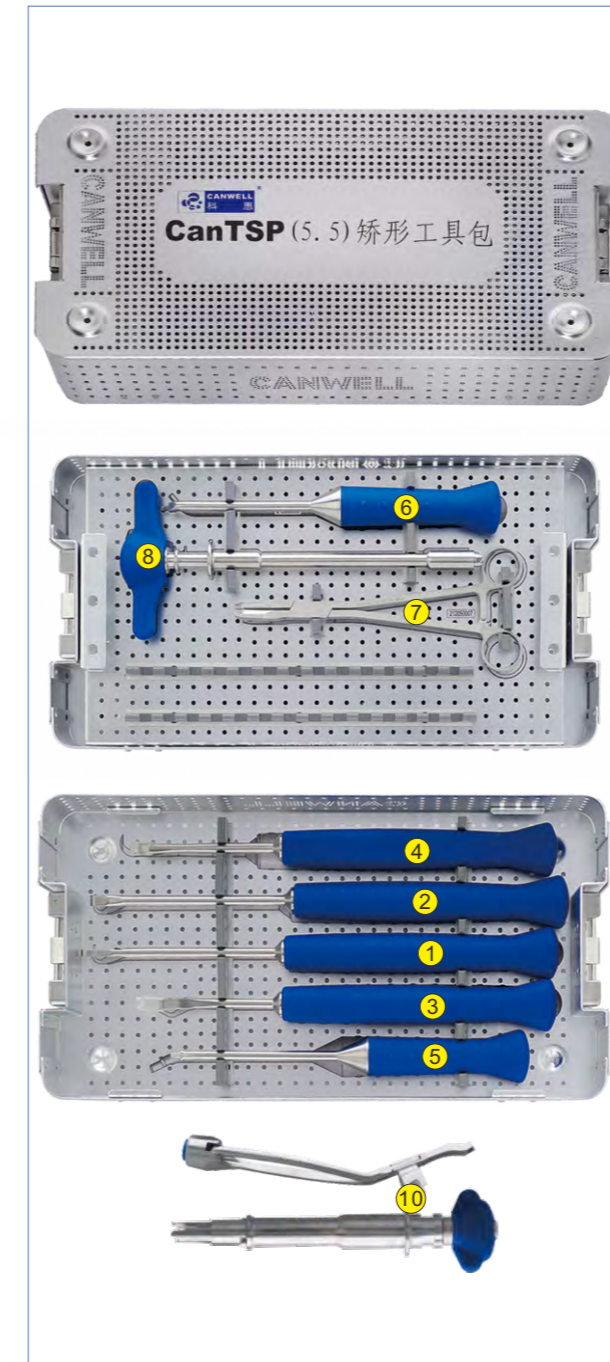

NO.	P.N	Description	Qty.
1	212050001	Wide blade Lamina Elevator	1
2	212050002	Narrow blade Lamina Elevator	1
3	212050003	Pedicle Elevator	1
4	212050004	Transverse Process Elevator	1
5	212050005	Hook Pusher for Implant Holder	1
6	212050006	Implant Pusher for Dual Purpose Instrument	1
7	212050007	Lateral Implant Holder	2
8	212050008	Dual Purpose Instrument	1
9	212057000	Universal Spinal Screw Tray	1
10	212050066	Lateral Translator	1
11	212252000	Instruments Tray	1

Posterior Thoracolumbar Fixation System CanTLF

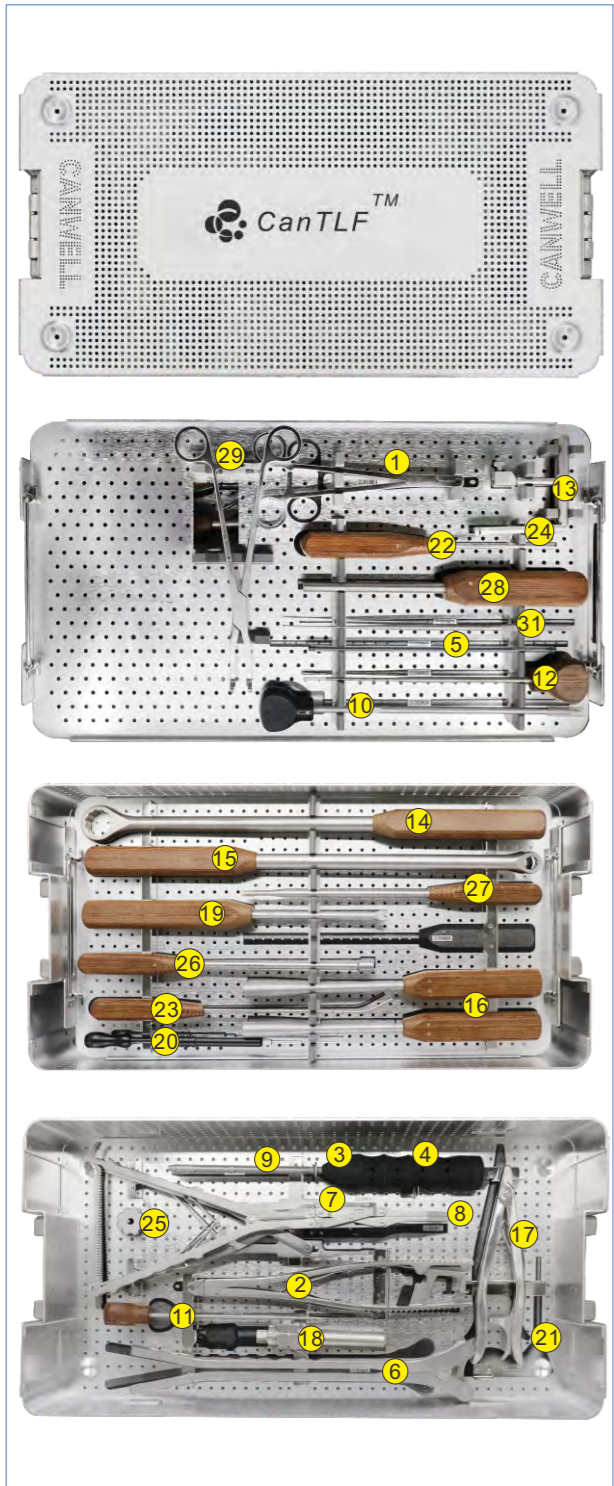

NO.	P.N	Description	Qty.
1	212010014	Rod Holder	1
2	212010018	Power Grip,Length 293mm	1
3	212010021	Marker Inserter(cylindrical) Length 80mm	3
4	212010022	Marker Inserter(sphere) Length 80mm	3
5	212020029	Rod Template Length 210mm	1
6	212020013	Rod Bender Length 283mm	1
7	212020014	Parallel Distraction Forceps Length 330mm	1
8	212020015	Parallel Compression Forceps Length 330mm	1
9	212020018	Pedicle Marker Inserter,Length 318mm	1
10	212020024	Awl,Length 227mm	1
11	212040001	Φ2.8 Pedicle Probe	1
12	212040002	Φ3.8 Pedicle Probe	1
13	212040003	T-Handle	1
14	212040004	Post Break-off Wrench(large)	1
15	212040005	Post Break-off Wrench(small)	1
16	212040006	Sw11 Socket Wrench	2
17	212040008	Screw Clamp	1
18	212040007	Bolt Cutting Head	1
19	212040011	Rod Pusher	1
20	212040012	Depth Gauge	1
21	212040013	Funnel for Cancellous Bone Graft	1
22	212040014	Cancellous Bone Impactor(straight)	1
23	212040015	Cancellous Bone Impactor(bent)	1
24	212040016	Reduction Sleeve	2
25	212040017	Nut	2
26	212040018	Sw8 Sleeve Wrench	1
27	212040019	Screwdriver for crosslink	1
28	212040020	Sw6 Sleeve Wrench	1
29	212040021	Hook Holder	1
30	212043000	Instrument Tray	1
31	212030022	Feeler for Screw Channel, straight Length 225mm	1

Posterior Lumbar Interbody Fusion System CanPEEK-P

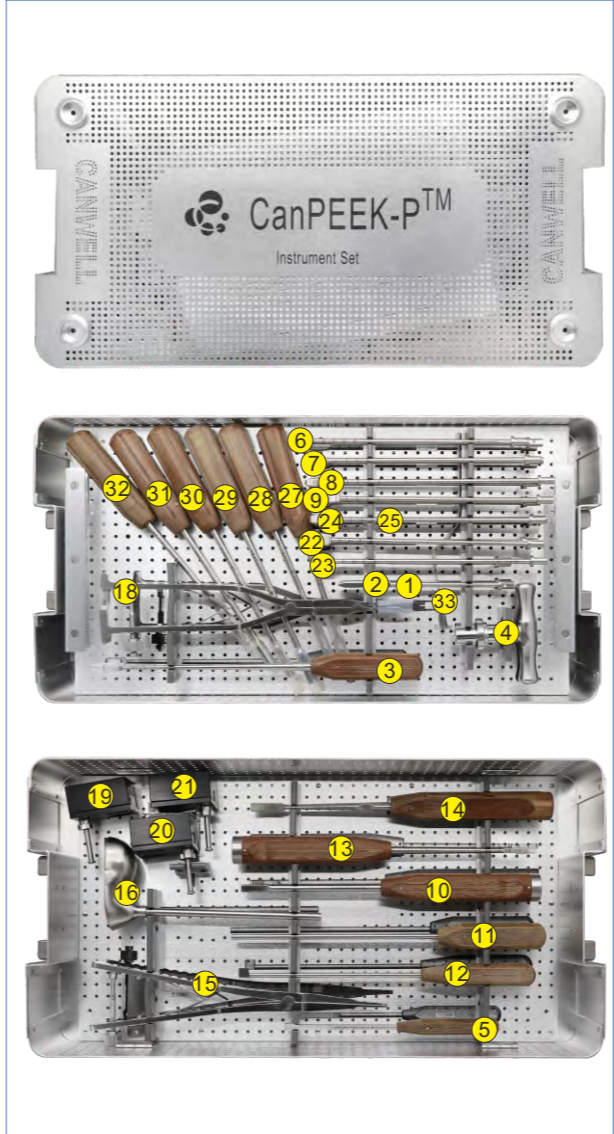

NO.	P.N	Description	Qty.
1	213310001	Disc Space Opener, width 4mm, height 8mm	1
2	213310002	Disc Space Opener, width 5mm, height 9mm	1
3	213320001	Bone Curette, rectangular, straight, 8.0mm	1
4	213320002	T-Handle with Quick Coupling	1
5	213320003	Cancellous Bone Impactor, 8x2.5mm	1
6	213320005	Trial Implant, size 7mm	2
7	213320006	Trial Implant, size 9mm	2
8	213320007	Trial Implant, size 11mm	2
9	213320008	Trial Implant, size 13mm	2
10	213320011	Impactor for PLIF spacer	1
11	213320012	Bone graft pusher, Φ8.0mm, for use with Funnel	1
12	213320013	Bone graft packer	1
13	213320015	Osteotome, 5mm	1
14	213320016	Bone Rasp, straight, 8mm	1
15	213320017	Distractor	1
16	213320018	Bone Graft funnel, Φ8.0mm, length 220mm	1
17	213323000	Instruments Tray	1
18	213320032	Implant Holder	1
19	213320029	Packing Block(width 8mm)	1
20	213320030	Packing Block(width 10mm)	1
21	213320031	Packing Block(width 12mm)	1
22	213320033	Trial Implant(8×24 9mm) 9MM)	1
23	213320034	Trial Implant(10×22 9mm)	1
24	213320035	Trial Implant(10×24 9mm)	1
25	213320036	Trial Implant(12×22 9mm)	1
26	213320037	Trial Implant(12×24 9mm)	1
27	213320022	Cannulated Bone Curette (rectangular, Large)	1
28	213320023	Cannulated Bone Curette (rectangular, Middle)	1
29	213320024	Cannulated Bone Curette (rectangular, Small)	1
30	213320025	Cannulated Bone Curette( round, Large)	1
31	213320026	Cannulated Bone Curette( round, Middle)	1
32	213320027	Cannulated Bone Curette( round, Small)	1
33	213320028	Retractor	1

Transforaminal Lumbar Interbody Fusion System CanPEEK-T

Transforaminal Lumbar Interbody Fusion System CanPEEK-T  
213419000

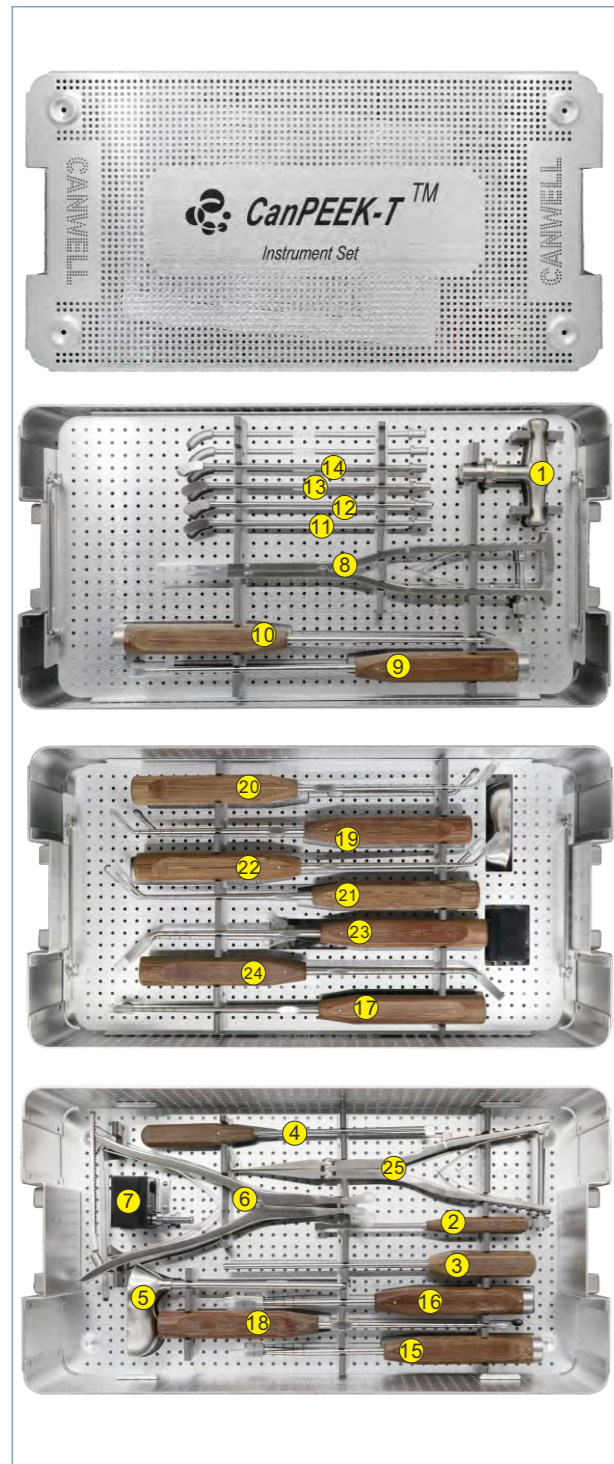

NO.	P.N	Description	Qty.
1	213320002	T-Handle with Quick Coupling	1
2	213320003	Cancellous Bone Impactor, 8x2.5mm	1
3	213320012	Bone graft pusher, Φ8.0mm, for use with Funnel	1
4	213320013	Bone graft packer	1
5	213320018	Bone Graft funnel, Φ8.0mm, length 220mm	1
6	213410001	Lamina Spreader for CanPEEK-T	1
7	213410002	Packing Block for CanPEEK-T	1
8	213410003	Implant Holder for CanPEEK-T	1
9	213410004	Impactor, straight	1
10	213410005	Impactor, curved	1
11	213410006	Trial Implant, size 7mm	1
12	213410007	Trial Implant, size 9mm	1
13	213410008	Trial Implant, size 11mm	1
14	213410009	Trial Implant, size 13mm	1
15	213410012	Osteotome, straight, 8mm	1
16	213410013	Osteotome, straight, 12mm	1
17	213410014	Bone Curette, straight, 7.5mm	1
18	213410015	Reverse angle, Bone Curette, straight, 7.5mm	1
19	213410016	Bone Curette, right angled, 7.5mm	1
20	213410017	Bone Curette, left angled, 7.5mm	1
21	213410018	Bone Curette, rectangular, right, 8mm	1
22	213410019	Bone Curette, rectangular, left, 8mm	1
23	213410020	Bone Rasp, left, 8mm	1
24	213410021	Bone Rasp, right, 8mm	1
25	213410022	Distractor	1
26	213413000	Instrument Tray	1

Anterior Cervical Interbody Fusion System CanPEEK-C

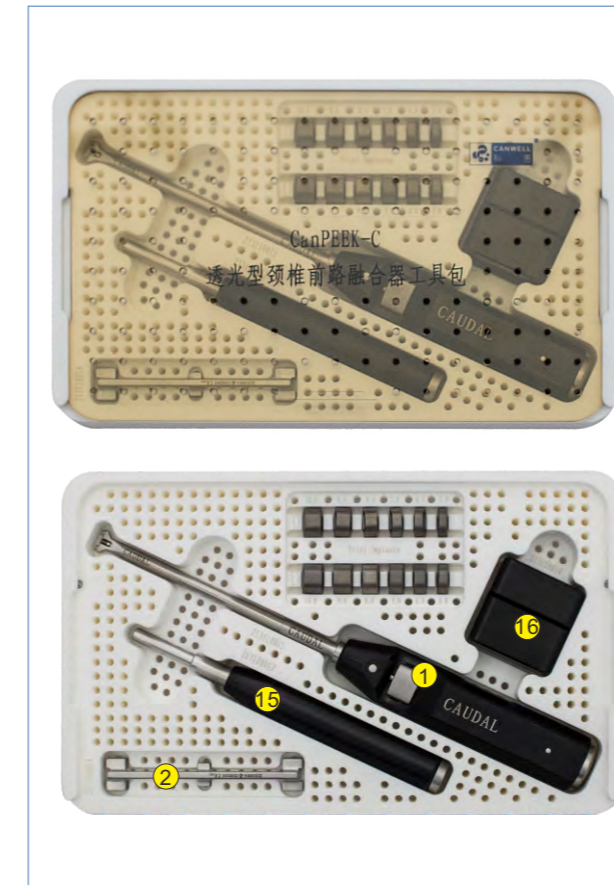

NO.	P.N	Description	Qty.
1	213110011	Implant Holder	1
2	213110014	Depth Limiter	1
3	213120001	5mm Wedge-shaped Trial Implant	1
4	213120002	6mm Wedge-shaped Trial Implant	1
5	213120003	7mm Wedge-shaped Trial Implant	1
6	213120004	8mm Wedge-shaped Trial Implant	1
7	213120005	9mm Wedge-shaped Trial Implant	1
8	213120006	10mm Wedge-shaped Trial Implant	1
9	213120007	5mm Curved Trial Implant	1
10	213120008	6mm Curved Trial Implant	1
11	213120009	7mm Curved Trial Implant	1
12	213120010	8mm Curved Trial Implant	1
13	213120011	9mm Curved Trial Implant	1
14	213120012	10mm Curved Trial Implant	1
15	213120013	Cancellous Bone Impactor	1
16	213120014	Packing Block	1
17	213125000	Instruments Tray(CanPEEK-C)	1

Posterior Lumbar Interbody Fusion System CanPEEK-V

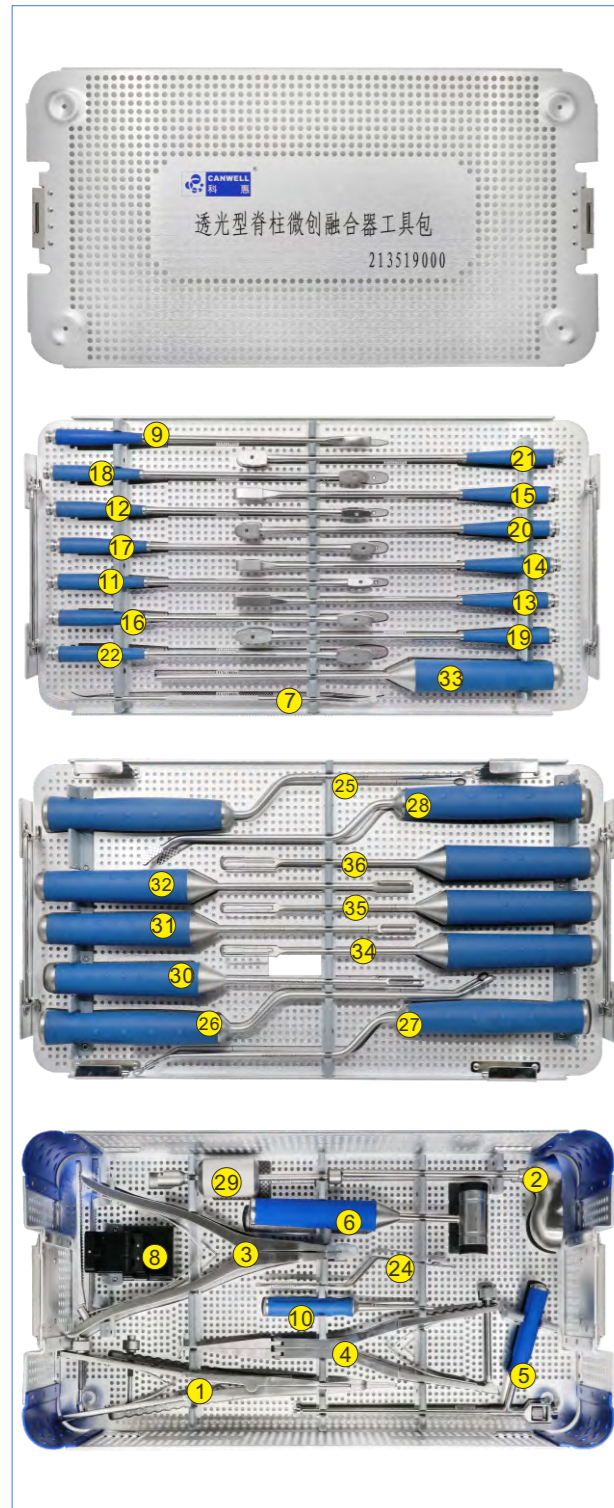

NO.	P.N	Description	Qty.
1	213320017	Distractor	1
2	213320018	Bone Graft funnel, Φ8.0mm, length 220mm	1
3	213410001	Lamina Spreader for CanPEEK-T	1
4	213410022	Distractor	1
5	213510001	Holder	1
6	213510002	Bone hammer	1
7	213510004	Nerve stripper	1
8	213510005	Bone graft	1
9	213510003	Open Circuit	1
10	213510006	Bone graft agitator(short)	1
11	213510007	Trial Implant(8x22)	1
12	213510008	Trial Implant(8x26)	1
13	213510009	Trial Implant(8x32)	1
14	213510011	Trial Implant(10x22)	1
15	213510012	Trial Implant(10x26)	1
16	213510013	Trial Implant(10x32)	1
17	213510015	Trial Implant(12x22)	1
18	213510016	Trial Implant(12x26)	1
19	213510017	Trial Implant(12x32)	1
20	213510019	Trial Implant(14x22)	1
21	213510020	Trial Implant(14x26)	1
22	213510021	Trial Implant(14x32)	1
23	213514000	Instruments Tray	1
24	213320028	Bone hook	1
25	213610018	Cup-shaped curette, straight	1
26	213610019	Cup-shaped curette, left	1
27	213610020	Cup-shaped curette, right	1
28	213610025	Bone Rasp	1
29	213610031	Nerve stripper	1
30	213619001	Bone curette (small reamer)	1
31	213619002	Bone curette (middle reamer)	1
32	213619003	Bone curette (large reamer)	1
33	213619004	Bone graft agitator(long)	1
34	213610036	Bone curette (scraper small)	1
35	213610034	Bone curette (scraper middle)	1
36	213610035	Bone curette (scraper large)	1

Lateral Lumbar Interbody Fusion System CanPEEK-L

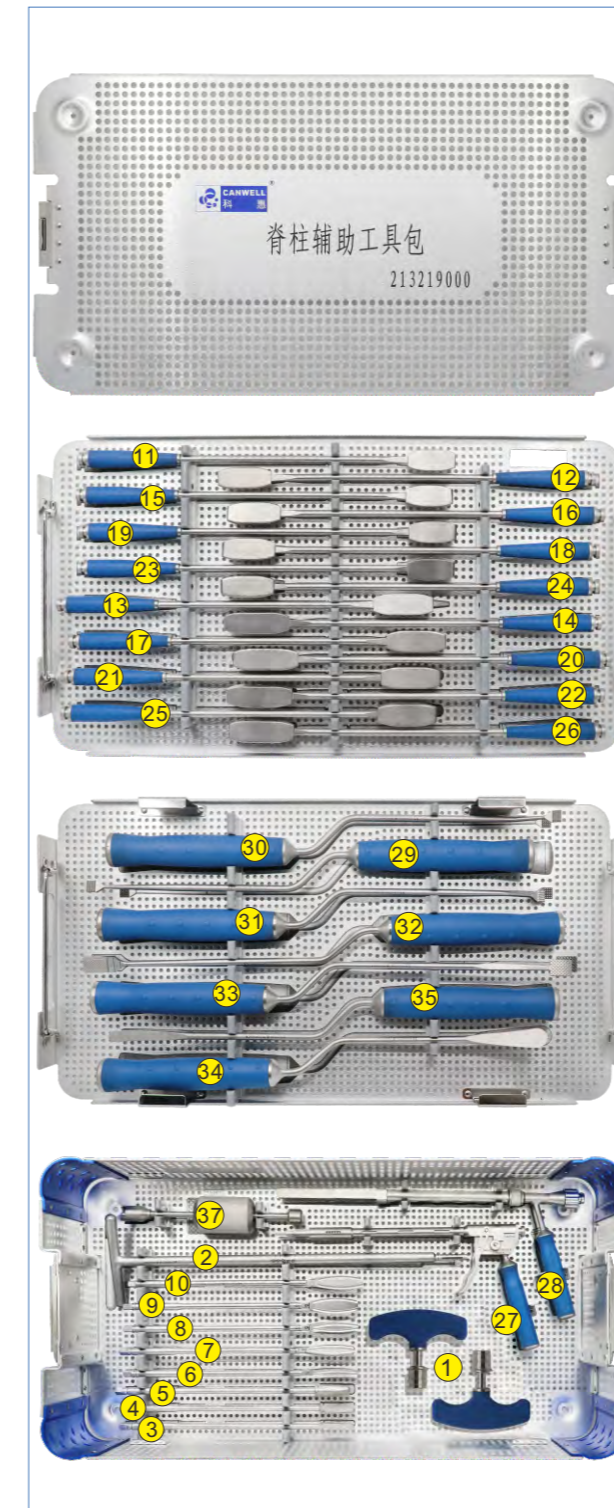

NO.	P.N	Description	Qty.
1	212050081	T-Handle with Quick Coupling	2
2	213210001	Ring drill	1
3	213210002	Spinal expander(6/8)	1
4	213210003	Spinal expander(8/10)	1
5	213210004	Spinal expander (10/12)	1
6	213210005	Bone knife (curette 8MM)	1
7	213210006	Bone knife (curette 10MM)	1
8	213210007	Bone knife (curette 12MM)	1
9	213210008	Bone knife (curette 14MM)	1
10	213210009	Bone knife (curette 16MM)	1
11	213210010	Impactor(8x40)	1
12	213210011	Impactor(8x45)	1
13	213210012	Impactor(8x50)	1
14	213210013	Impactor(8x55)	1
15	213210014	Impactor(10x40)	1
16	213210015	Impactor(10x45)	1
17	213210016	Impactor(10x50)	1
18	213210017	Impactor(10x55)	1
19	213210018	Impactor(12x40)	1
20	213210019	Impactor(12x45)	1
21	213210020	Impactor(12x50)	1
22	213210021	Impactor(12x55)	1
23	213210022	Impactor(14x40)	1
24	213210023	Impactor(14x45)	1
25	213210024	Impactor(14x50)	1
26	213210025	Impactor(14x55)	1
27	213210026	Extractor	1
28	213210027	Holder	1
29	213210028	Bone Rasp(straight)	1
30	213210029	Bone Rasp(upper bend)	1
31	213210030	Bone Rasp(bend down)	1
32	213210031	Bone Rasp(square)	1
33	213210032	Bone Rasp(arc)	1
34	213210033	Periosteal stripper(wide)	1
35	213210034	Periosteal stripper(narrow)	1
36	213212000	Instruments Tray	1
37	213610031	Bone hammer	1

Spine Minimally Invasive Channel System CanMIC

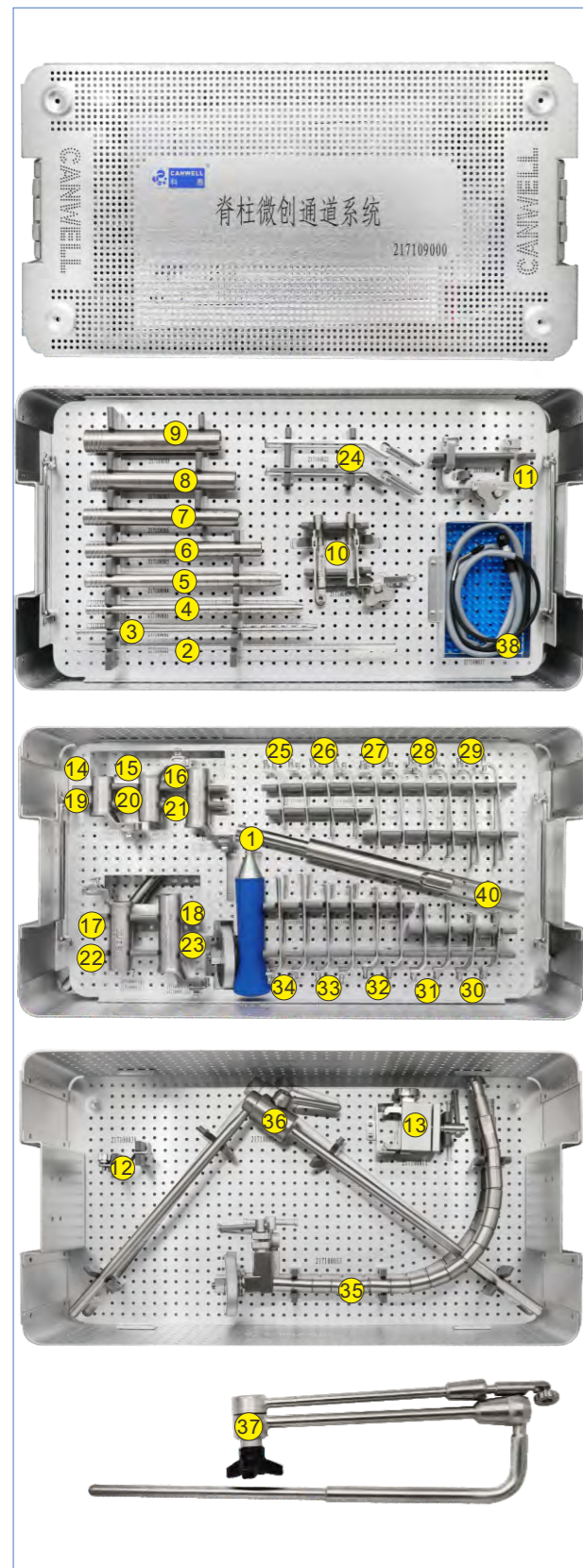

NO.	P.N	Description	Qty.
1	212050036	Counter Torque Screwdriver	1
2	217100001	Guide Wire	1
3	217100002	Dilatation tube	1
4	217100003	Dilatation tube	1
5	217100004	Dilatation tube	1
6	217100005	Dilatation tube	1
7	217100006	Dilatation tube	1
8	217100007	Dilatation tube	1
9	217100008	Dilatation tube	1
10	217100009	Distractor	1
11	217100010	Side distractor	1
12	217100039	Free arm connector	1
13	217100011	Flex Arm	1
14	217100012	Distraction blade(right)40mm	1
15	217100013	Distraction blade(right)50mm	1
16	217100014	Distraction blade(right)60mm	1
17	217100015	Distraction blade(right)70mm	1
18	217100016	Distraction blade(right)80mm	1
19	217100017	Distraction blade(left)40mm	1
20	217100018	Distraction blade(left)50mm	1
21	217100019	Distraction blade(left)60mm	1
22	217100020	Distraction blade(left)70mm	1
23	217100021	Distraction blade(left)80mm	1
24	217100022	Blade wrench	2
25	217100023	Side baffle(narrow) 50mm	2
26	217100024	Side baffle(narrow) 60mm	2
27	217100025	Side baffle(narrow) 70mm	2
28	217100026	Side baffle(narrow) 80mm	2
29	217100027	Side baffle(narrow) 90mm	2
30	217100028	Side baffle(blade) 50mm	2
31	217100029	Side baffle(blade) 60mm	2
32	217100030	Side baffle(blade) 70mm	2
33	217100031	Side baffle(blade) 80mm	2
34	217100032	Side baffle(blade) 90mm	2
35	217100033	Flexible bracket	1
36	217100034	Flexible bracket arm	1
37	217100036	Rigid bracket	1
38	217100037	Minimally Invasive channel attachment	1
39	217110000	Instrument tray	1
40	217100041	Pressurized blade	1

Lateral Spine Minimally Invasive Channel System CanMIC-L

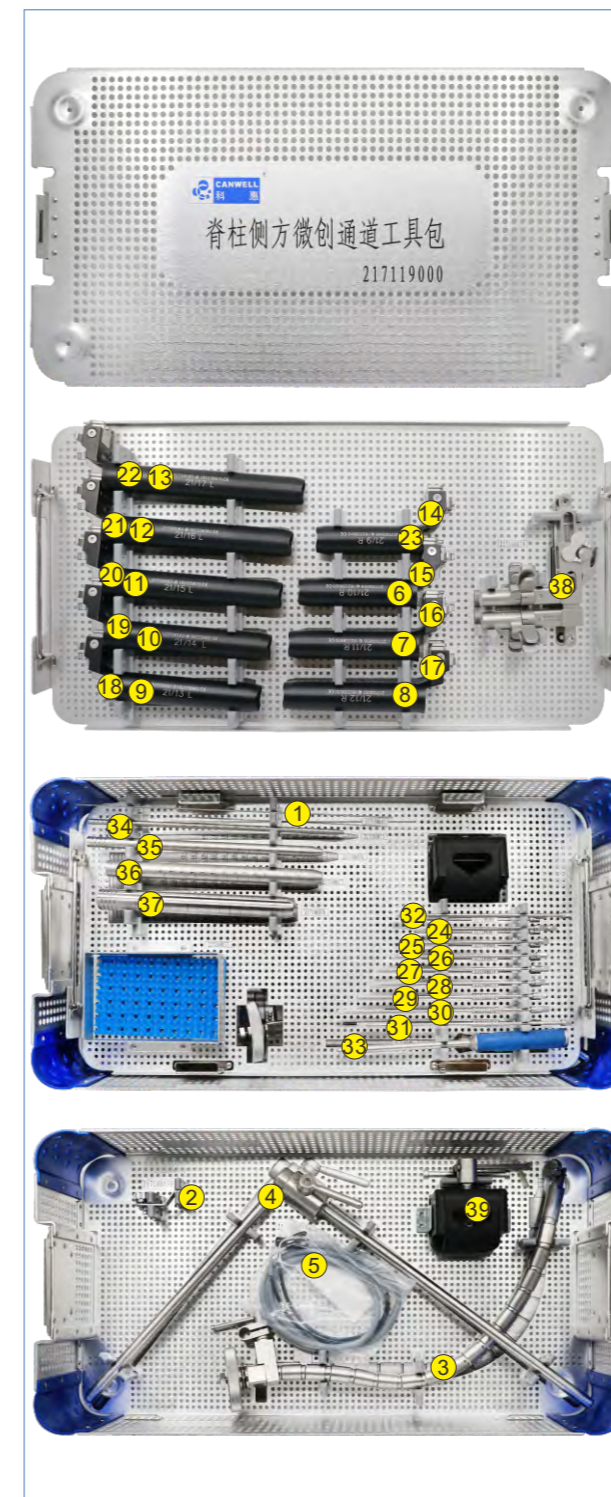

NO.	P.N	Description	Qty.
1	217100001	Guide Wire	1
2	217100039	Free arm connector	1
3	217100033	Flexible bracket	1
4	217100034	Flexible bracket arm	1
5	217100037	Minimally Invasive channel attachment	1
6	217100049	Minimally invasive retractor(right 100)	1
7	217100050	Minimally invasive retractor(right 110)	1
8	217100051	Minimally invasive retractor(right 120)	1
9	217100052	Minimally invasive retractor(right 130)	1
10	217100053	Minimally invasive retractor(right 140)	1
11	217100054	Minimally invasive retractor(right 150)	1
12	217100055	Minimally invasive retractor(right 160)	1
13	217100056	Minimally invasive retractor(right 170)	1
14	217100048	Minimally invasive retractor(right 90)	1
15	217100058	Minimally invasive retractor(left 100)	1
16	217100059	Minimally invasive retractor(left 110)	1
17	217100060	Minimally invasive retractor(left 120)	1
18	217100061	Minimally invasive retractor(left 130)	1
19	217100062	Minimally invasive retractor(left 140)	1
20	217100063	Minimally invasive retractor(left 150)	1
21	217100064	Minimally invasive retractor(left 160)	1
22	217100065	Minimally invasive retractor(left 170)	1
23	217100057	Minimally invasive retractor(left 90)	1
24	217100067	Bone traction needle(100)	2
25	217100068	Bone traction needle(110)	2
26	217100069	Bone traction needle(120)	2
27	217100070	Bone traction needle(130)	2
28	217100071	Bone traction needle(140)	2
29	217100072	Bone traction needle(150)	2
30	217100073	Bone traction needle(160)	2
31	217100074	Bone traction needle(170)	2
32	217100066	Bone traction needle(90)	2
33	217100086	screwdriver	1
34	217100075	Dilatation tube	1
35	217100076	Dilatation tube	1
36	217100077	Dilatation tube	1
37	217100078	Dilatation tube	1
38	217100079	Distractor	1
39	217100080	Connector	1
40	217102000	Instrument tray	1

Posterior Thoracolumbar Fixation System Instrument Set CanPSS

Posterior Thoracolumbar Fixation System Instrument Set CanPSS  
216129000

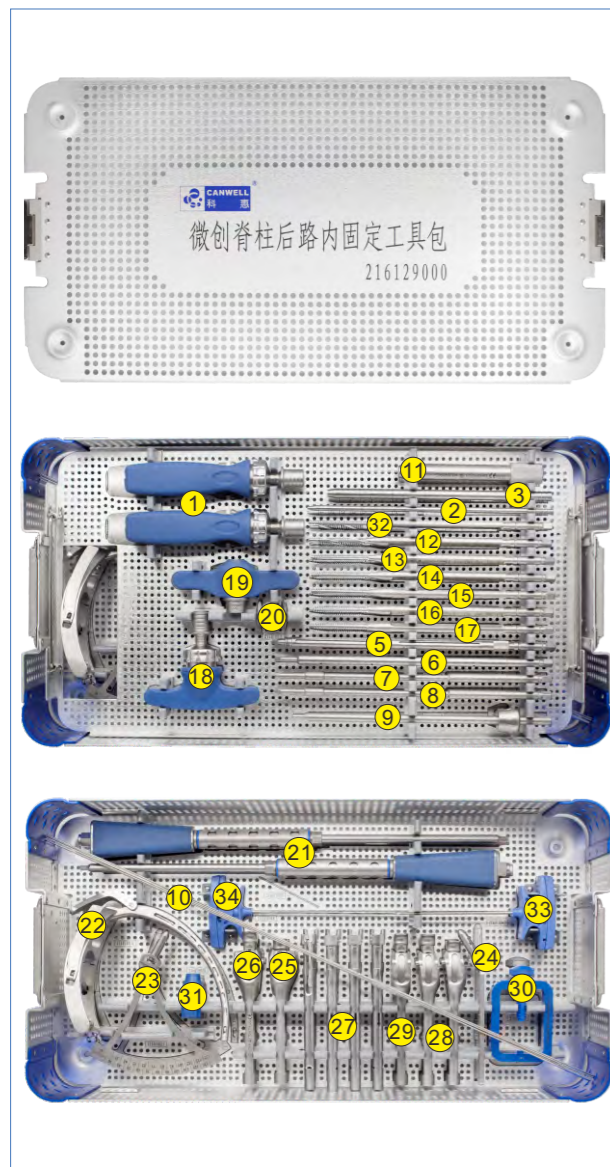

NO.	P.N	Description	Qty.
1	212050013	Quick Coupling Handle	2
2	217100002	Dilatation tube	1
3	217100003	Dilatation tube	1
4	212057900	Universal Spinal Screw Tray	1
5	216010033	Screwdriver	2
6	216010034	Orthopedic screwdriver	1
7	216010035	Orthopedic screwdriver	1
8	216010036	Orthopedic screwdriver	1
9	216010038	Bone probe	1
10	216010003	Guide Wire	6
11	216010004	Φ15.0 Dilator	1
12	216010006	Wire tapping(thin)	1
13	216010007	(Φ5.5)Tap(Φ5.5)	1
14	216010008	(Φ6.0)Tap (Φ6.0)	1
15	216010009	(Φ6.5)Tap (Φ6.5)	1
16	216010010	(Φ7.0)Tap (Φ7.0)	1
17	216010011	(Φ7.5)Tap(Φ7.5)	1
18	216010012	Quick Connection T-Handle	1
19	216010013	Break-off T-Handle	1
20	216010018	Rod Trocar Tip	2
21	216010019	Set Screw Retaining Compressors	2
22	216010020	Rod Inserter	1
23	216010021	Reduction Stationary Rod	1
24	216010022	Template	1
25	216010023	Single-level Reduction Extender A	1
26	216010024	Single-level Reduction Extender B	1
27	216010025	Reduction Inner sleeve	4
28	216010026	Multi-Level Reduction Extender A	2
29	216010027	Multi-Level Reduction Extender B	1
30	216010028	Radiolucent Clamp	1
31	216010029	Alignment Guide	1
32	216010046	Tap	1
33	216010047	Open Circuit(short)	2
34	216010048	Open Circuit(long)	1
35	216122000	Instrument tray	1

CanPSS - Reduction Instrument Set

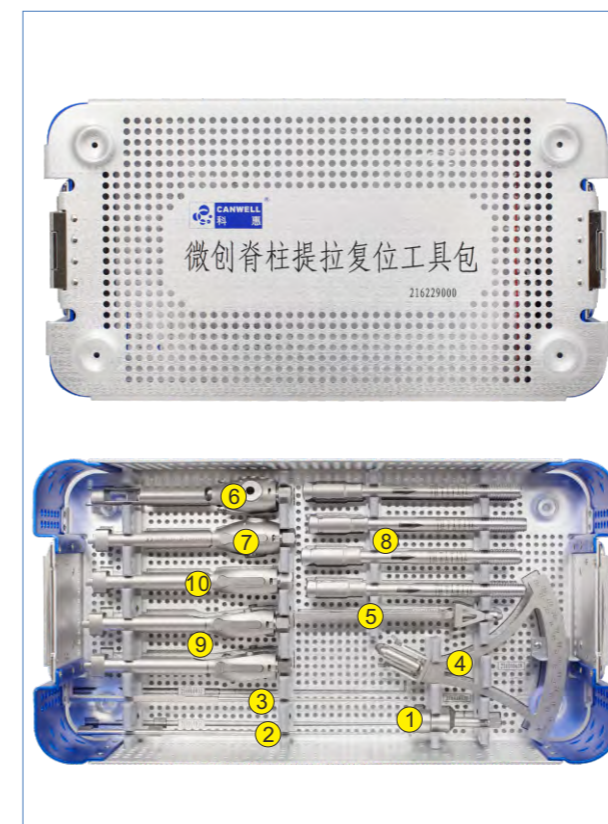

NO.	P.N	Description	Qty.
1	216010030	Reduction Nut Driver	1
2	216010031	Depth Gauge Slider	1
3	216010032	Depth Gauge Scale	1
4	216010039	Reduction Stationary Rod Template	1
5	216010040	Reduction Rod Pointer	1
6	216010041	Single-Level Reduction Extender B	1
7	216010042	Single-Level Reduction Extender A	1
8	216010043	Reduction Inner Sleeve	4
9	216010044	Multi-Level Outer Reduction Extenders	2
10	216010045	Multi-Level Middle Reduction Extenders	1
11	216222000	Instrument tray	1

Posterior Thoracolumbar Fixation System CanHELP 216329000

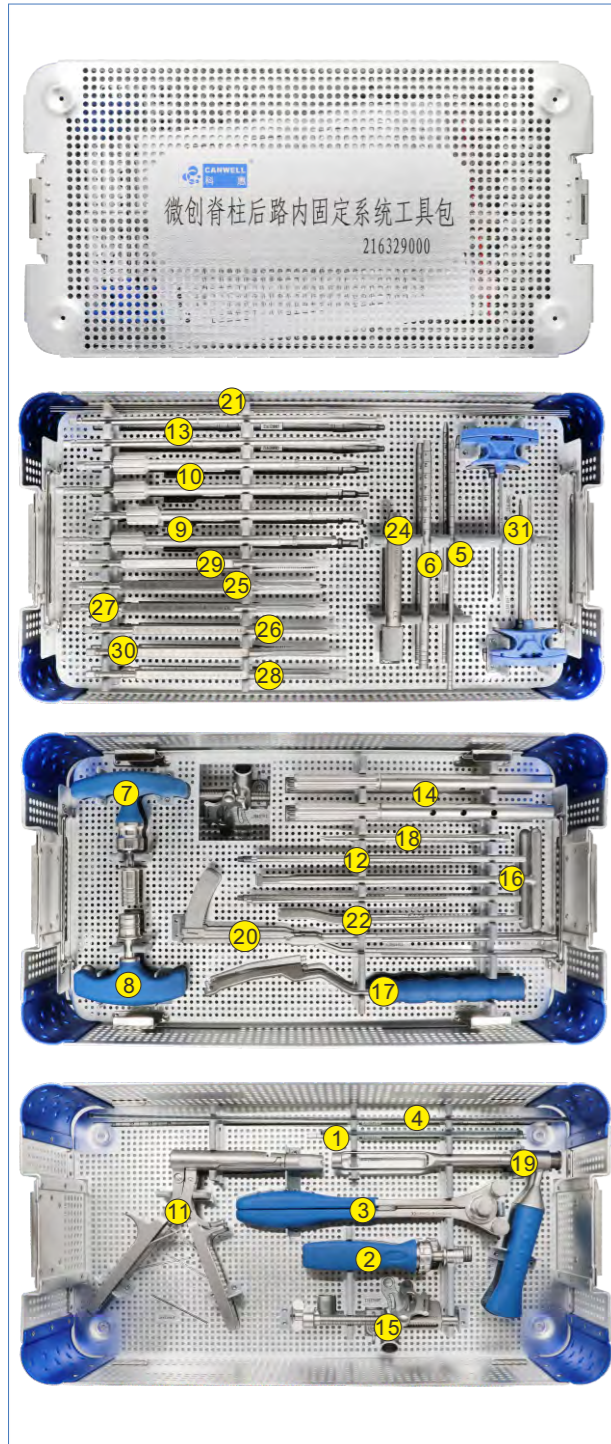

NO.	P.N	Description	Qty.
1	212020029	Rod Template Length 210mm	1
2	212050013	Quick Coupling Handle	1
3	212050043	Rod Bender	1
4	212050052	Rod Template(500mm)	1
5	217100002	Dilatation tube	1
6	217100003	Dilatation tube	1
7	212050079	Torque Limiter( 12.5N.M)	1
8	212050081	Quick Connection T-Handle	1
9	216320001	Monoaxial Screwdriver	2
10	216320002	Polyaxial Screwdriver	2
11	216320003	Reduction Forceps	1
12	216320004	Plug Starter	2
13	216320005	T30 driver	2
14	216320006	Extension sleeve	2
15	216320007	Distractor	1
16	216320008	Screw end adjuster	1
17	216320010	Rod implantor	1
18	216320011	T15 stardriver	1
19	216320012	Counter torque	1
20	216320013	Measurer	1
21	216320014	Guide wire	6
22	216320015	Reduction Screw Tab Breaker	1
23	216322000	Instrument tray	1
24	216010004	Φ15.0 Dilator	1
25	216010006	Wire tapping(thin)	1
26	216010007	Bone tap(Φ5.5)	1
27	216010008	Bone tap(Φ6.0)	1
28	216010009	Bone tap(Φ6.5)	1
29	216010010	Bone tap(Φ7.0)	1
30	216010046	Bone tap(Φ5.0)	1
31	216010047	Puncture Needle, 157mm	2